

Operation

Residential/Commercial Generator Sets



OnCue® Plus

Generator Management System
for Kohler® Residential/Light Commercial Generator Sets
equipped with the following controllers:

RDC/DC
RDC2/DC2
VSC

KOHLER
Power Systems

9001
KOHLER
POWER SYSTEMS
NATIONALLY REGISTERED

TP-6928 4/15d

Table of Contents

Safety Precautions and Instructions	5
Introduction	7
List of Related Literature	7
Service Assistance	8
Section 1 System Information and Installation	9
1.1 Kohler OnCue Plus	9
1.1.1 Mobile Apps	9
1.1.2 PIM and LCM	9
1.2 Connect and Monitor Multiple Generator Sets	10
1.3 Kohler OnCue Plus Server	10
1.4 Terms of Service	10
1.5 System Requirements	10
1.6 Internet Configuration and Security (Firewalls)	10
1.7 Controller Firmware Download and Installation	11
1.8 Controller Password and Serial Number	12
1.8.1 RDC2 and VSC Controller Password and Serial Number	12
1.8.2 DC2 Controller Password and Serial Number	12
1.8.3 RDC/DC Controller Password	12
1.8.4 Nameplate Serial Number	13
1.8.5 Activation Code	14
1.9 Connect the Generator to the Internet	14
1.9.1 OnCue Plus for RDC2/DC2/VSC	15
1.9.2 OnCue Plus Wireless for RDC2/DC2	16
1.9.3 RDC/DC Controller	17
1.9.4 OnCue Plus for RDC/DC	17
1.9.5 OnCue Plus Wireless for RDC/DC	18
Section 2 OnCue Plus Operation	19
2.1 Introduction	19
2.2 Information Required	19
2.3 Start OnCue Plus	19
2.4 DEMO Button	20
2.5 Send Feedback Button	20
2.6 Create an Account	21
2.7 Add New Generator	22
2.8 Activate Your Generator	23
2.9 OnCue Plus Views	24
2.10 Status	24
2.11 Select Generator	26
2.12 Event History	27
2.13 Controls	29
2.13.1 Start Exercise	29
2.13.2 Stop Exercise	30
2.13.3 PIM	31
2.13.4 Load Shed	31
2.14 Parameters	32
2.15 Dealer Communication	33
2.15.1 Enter Dealer Information	33
2.15.2 Email Your Dealer	33
2.16 Maintenance	34
2.16.1 Hours	34
2.16.2 Manage Exercise Details	34

Table of Contents, continued

2.17	Settings	36
2.17.1	Add or Delete Email Recipients	36
2.17.2	Text Message Configuration	37
2.17.3	Notifications	37
2.17.4	Select Event Notifications	38
2.17.5	Push Notifications	39
2.17.6	Data Refresh Interval	41
2.17.7	Generator Settings	42
2.17.8	Rename Outputs (PIM and Load Shed)	43
2.17.9	Dealer Information	44
2.17.10	Delete a Generator	44
Section 3	Troubleshooting	45
3.1	Introduction	45
3.2	Generator Set Serial Number	45
3.3	Verify Power to the Controller	45
3.4	Check Controller's Ethernet Connection	45
3.5	Power Cycling the Controller	45
3.6	Troubleshooting Flowchart	45
3.7	Network Configuration and Status	47
3.8	Check for Server Connection	47
3.8.1	RDC or DC Controllers	47
3.8.2	RDC2, DC2, or VSC Controller	47
3.9	Using Telnet	48
3.10	Other Issues	49
Appendix A	Abbreviations	51

Safety Precautions and Instructions

IMPORTANT SAFETY INSTRUCTIONS. Electromechanical equipment, including generator sets and accessories, can cause bodily harm and pose life-threatening danger when improperly installed, operated, or maintained. To prevent accidents be aware of potential dangers and act safely. Read and follow all safety precautions and instructions. **SAVE THESE INSTRUCTIONS.**

This manual has several types of safety precautions and instructions: Danger, Warning, Caution, and Notice.

DANGER

Danger indicates the presence of a hazard that **will cause severe personal injury, death, or substantial property damage.**

WARNING

Warning indicates the presence of a hazard that **can cause severe personal injury, death, or substantial property damage.**

CAUTION

Caution indicates the presence of a hazard that **will or can cause minor personal injury or property damage.**

NOTICE

Notice communicates installation, operation, or maintenance information that is safety related but not hazard related.

Safety decals affixed to the equipment in prominent places alert the operator or service technician to potential hazards and explain how to act safely. The decals are shown throughout this publication to improve operator recognition. Replace missing or damaged decals.

Accidental Starting

WARNING

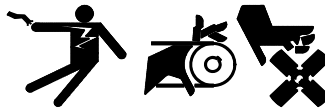

Accidental starting.
Can cause severe injury or death.

Disconnect the battery cables before working on the generator set. Remove the negative (-) lead first when disconnecting the battery. Reconnect the negative (-) lead last when reconnecting the battery.

Disabling the generator set. **Accidental starting can cause severe injury or death.** Before working on the generator set or equipment connected to the set, disable the generator set as follows: (1) Press the generator set off/reset button to shut down the generator set. (2) Disconnect the power to the battery charger, if equipped. (3) Remove the battery cables, negative (-) lead first. Reconnect the negative (-) lead last when reconnecting the battery. Follow these precautions to prevent the starting of the generator set by the remote start/stop switch.

Hazardous Voltage/ Moving Parts

DANGER



Hazardous voltage.
Will cause severe injury or death.

Disconnect all power sources before opening the enclosure.

Short circuits. **Hazardous voltage/current can cause severe injury or death.** Short circuits can cause bodily injury and/or equipment damage. Do not contact electrical connections with tools or jewelry while making adjustments or repairs. Remove all jewelry before servicing the equipment.

NOTICE

Electrostatic discharge damage. Electrostatic discharge (ESD) damages electronic circuit boards. Prevent electrostatic discharge damage by wearing an approved grounding wrist strap when handling electronic circuit boards or integrated circuits. An approved grounding wrist strap provides a high resistance (about 1 megohm), *not a direct short*, to ground.

Notes

This manual provides operation instructions for the OnCue® Plus Generator Management System. OnCue Plus is a web application that does not require the installation of software on your computer. OnCue Plus allows remote monitoring and control of your generator set using a computer, tablet, or smart phone from any location that provides web access.

OnCue Plus applies to Kohler® Residential and Light Commercial generator sets equipped with the following controllers:

- RDC/DC
- RDC2/DC2
- VSC

Note: The RDC2, DC2, and VSC controllers require an activation code, which is supplied with the OnCue Plus kit.

Note: The RDC and DC controllers must be equipped with the Ethernet option board kit GM62465-KP1. See TT-1566, provided with the kit, for installation instructions.

Information in this publication represents data available at the time of print. Kohler Co. reserves the right to

change this publication and the products represented without notice and without any obligation or liability whatsoever.

Read this manual and carefully follow all procedures and safety precautions to ensure proper equipment operation and to avoid bodily injury. Read and follow the Safety Precautions and Instructions section at the beginning of this manual. Keep this manual with the equipment for future reference.

List of Related Literature

Figure 1 lists related literature.

Literature Type	Part Number
OnCue Plus Specification Sheet	G6-140
OnCue Plus Wireless Specification Sheet	G6-137
Ethernet Option Board Installation Instructions (RDC/DC only)	TT-1566
OnCue Plus Wireless Kit Installation Instructions	TT-1618
USB Utility Instructions	TT-1636

Figure 1 Related Literature

Service Assistance

For professional advice on generator set power requirements and conscientious service, please contact your nearest Kohler distributor or dealer.

- Consult the Yellow Pages under the heading Generators—Electric.
- Visit the Kohler Power Systems website at KOHLERPower.com.
- Look at the labels and stickers on your Kohler product or review the appropriate literature or documents included with the product.
- Call toll free in the US and Canada 1-800-544-2444.
- Outside the US and Canada, call the nearest regional office.

Headquarters Europe, Middle East, Africa (EMEA)

Kohler Power Systems Netherlands B.V.
Kristallaan 1
4761 ZC Zevenbergen
The Netherlands
Phone: (31) 168 331630
Fax: (31) 168 331631

Asia Pacific

Power Systems Asia Pacific Regional Office
Singapore, Republic of Singapore
Phone: (65) 6264-6422
Fax: (65) 6264-6455

China

North China Regional Office, Beijing
Phone: (86) 10 6518 7950
(86) 10 6518 7951
(86) 10 6518 7952
Fax: (86) 10 6518 7955

East China Regional Office, Shanghai
Phone: (86) 21 6288 0500
Fax: (86) 21 6288 0550

India, Bangladesh, Sri Lanka

India Regional Office
Bangalore, India
Phone: (91) 80 3366208
(91) 80 3366231
Fax: (91) 80 3315972

Japan, Korea

North Asia Regional Office
Tokyo, Japan
Phone: (813) 3440-4515
Fax: (813) 3440-2727

Latin America

Latin America Regional Office
Lakeland, Florida, USA
Phone: (863) 619-7568
Fax: (863) 701-7131

Section 1 System Information and Installation

1.1 Kohler OnCue Plus

A device such as a personal computer (PC), smart phone, or tablet running the Kohler® OnCue® Plus application can communicate with the generator set models listed in the Introduction section to monitor the generator set from any location with Internet access. You can also use your device to signal the generator set controller to start or stop the engine or to reset a fault.

Once OnCue Plus has been purchased and activated for a specific generator set, that generator can be monitored from multiple devices and locations. The Kohler OnCue Plus application can be used on one or more personal computers (PCs), smart phones, or tablets, allowing monitoring and control of your Kohler generator set from any location with Internet access. Use OnCue Plus to monitor your generator set from home, at work, or on vacation. The generator serial number, controller password, and OnCue Plus account password provide security and prevent unauthorized access to your generator set.

OnCue Plus also provides the ability to automatically send email, text messages, or push notifications to notify selected recipients of generator set activity, faults, and maintenance reminders.

1.1.1 Mobile Apps

OnCue Plus for iPhone®, iPad® and Android™ devices is available on the App StoreSM and Google Play™. Mobile app operation is similar to the web application operation described in this manual. For instructions to use the app, refer to the Quick Start guide for the app.

1.1.2 PIM and LCM

If the power system includes a programmable interface module (PIM), load control module (LCM) or load shed kit, OnCue Plus also allows remote control of electric items in your home. See Section 2.13 for more information.

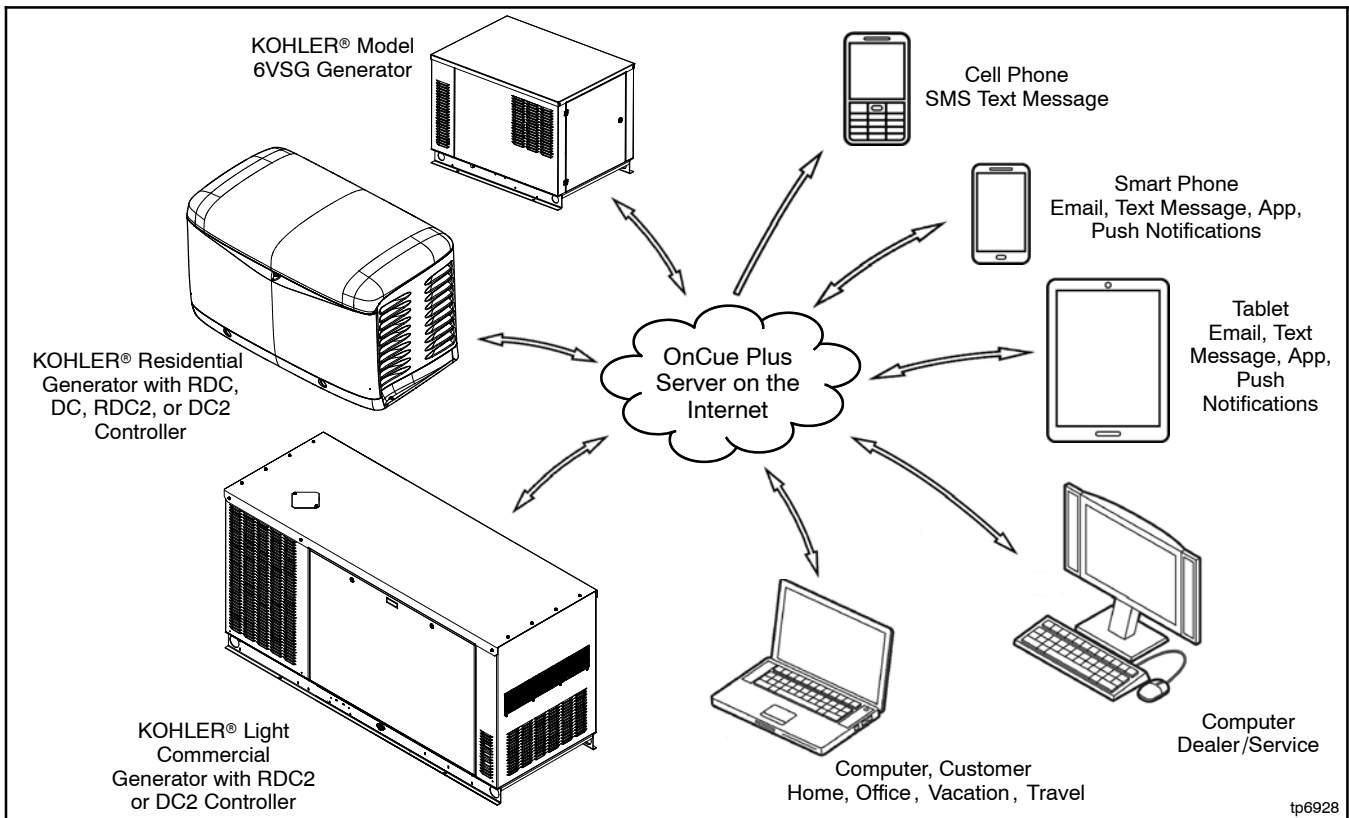

Figure 1-1 Kohler® OnCue® Plus Generator Management System

Apple, the Apple logo, iPhone and iPad are registered trademarks of Apple Inc., registered in the U.S. and other countries. App Store is a service mark of Apple Inc.

Android and Google Play are trademarks of Google Inc.

1.2 Connect and Monitor Multiple Generator Sets

If you own more than one generator set, or if you are a dealer monitoring numerous customer systems, you may use Kohler OnCue® Plus to monitor multiple generator sets. Purchase one OnCue Plus or OnCue Plus Wireless kit for **each** generator set that you want to monitor and control remotely.

To connect to each generator set, enter the serial number, password, and activation code (if required) for the generator set as described in Section 2.7. Each generator set needs to be added to your account only once.

Generator sets can also be removed from your account. See Section 2.17.10 for instructions to delete a generator from your account.

1.3 Kohler OnCue Plus Server

Kohler Power Systems operates an Internet server system used to connect Kohler generator sets to the Kohler® OnCue Plus application.

All connections to the Kohler OnCue Plus Server are fully encrypted for your protection. See Section 1.4, Privacy Statement.

1.4 Terms of Service

Click on the Terms of Service link and review the OnCue terms and conditions of use when you set up your OnCue Plus account. See Section 2.6. By accepting the OnCue terms and conditions of use, you are acknowledging that you have read the OnCue terms and conditions of use and agreeing to be bound by the OnCue terms and conditions of use.

If you have questions or concerns about the OnCue terms and conditions of use, please contact Kohler Co. by email at privacy@kohler.com, or call 1-800-544-2444. Kohler Co. may update the OnCue terms and conditions of use at any time.

1.5 System Requirements

The following items are the minimum requirements and recommendations for connecting your generator to the Internet.

- “Always-on” Internet service for generator set connection (for example, cable, DSL, or phone line modem connected 24 hours)
- Unused Ethernet port on a switch, router, or modem
- An uninterruptible power supply (UPS) for the modem and router is recommended.

- OnCue Plus requires a customer-supplied network cable for connection of the generator set to the customer’s Ethernet router

OR

OnCue Plus Wireless requires the wireless access point, included in the OnCue Plus Wireless kit, and a customer-supplied wireless router for Internet access. The wireless router will typically be the same router that the customer uses for connecting his computer to the Internet and will be located near the computer.

- Controller firmware versions shown in Section 1.7. It may be necessary to update the firmware on the controller. Contact your Kohler distributor or dealer, or use the Kohler USB Utility to update the firmware yourself. Visit www.KohlerGenerators.com/usb to obtain the USB Utility.
- USB cable, male USB A to male mini-B, for updating the controller firmware
- **RDC2, DC2, or VSC only:** The generator set serial number, password, and OnCue Activation Code found on the decal, included with the OnCue Plus kits.
- **RDC or DC only:** The generator set serial number, password, and Ethernet option board installed on the generator set controller, included with the OnCue Plus kits.

1.6 Internet Configuration and Security (Firewalls)

When the generator set is connected to an intranet network behind a firewall, for example in a commercial or industrial setting, it may be necessary to configure the firewall to open port 5253 to permit an outbound connection. Contact your network administrator for assistance if necessary.

1.7 Controller Firmware Download and Installation

It may be necessary to update the firmware on your generator set controller. See Figure 1-2 for the firmware version required for your device. Use the version shown or a later version, if available. Refer to the generator set documentation for instructions to find the version number installed on your controller.

Note: The Kohler OnCue® Plus application cannot be used to update controller firmware. Controller firmware can be updated by a Kohler authorized distributor or dealer using a personal computer and Kohler® SiteTech™ software or the Kohler USB Utility. If you would like to upgrade the firmware yourself, use the USB utility. Visit www.KohlerGenerators.com/usb to obtain the USB utility and instructions.

Firmware Version Numbers

Software and firmware version numbers consist of three parts separated by periods (or dots) as follows:

[Major version number].[Minor version number].[Build number]

For example, if the version number is 2.3.17, the major version number is 2, the minor version number is 3 and the build number is 17. The build number is typically not shown on the controller display, but is included in the firmware file name.

Note: Preceding zeros may be dropped from version numbers for software and firmware. For example, firmware version 2.3 is the same as version 2.03. However, version 2.1 (two point one) is *not* the same as 2.10 (two point ten).

Model	Controller	Firmware Version Number *	Firmware File Name †
6VSG	VSC	1.14 or higher	VSC_#_#_#.bin
14/20RES	RDC	3.18 or higher	RDC_#_#_#.bin
14/20RESL	DC	3.18 or higher	RDC_#_#_#.bin
14/20RESA	RDC2	5.07 or higher	RDC2_#_#_#.bin
	RDC2 with APM	105.5 or higher	RDC2_#_#_#.bin
14/20RESAL	DC2	5.07 or higher	RDC2_#_#_#.bin
20RESB	RDC2	5.07 or higher	RDC2_#_#_#.bin
38RCL	RDC2	5.07 or higher	RDC2_#_#_#.bin
48RCL	RDC2	5.07 or higher	RDC2_#_#_#.bin
60RCL	RDC2	5.07 or higher	RDC2_#_#_#.bin
24RCL	RDC2	6.01 or higher	RDC2_#_#_#.bin
30RCLH	RDC2	6.01 or higher	RDC2_#_#_#.bin

* This firmware version number or higher is required for monitoring with OnCue Plus. See Note about version numbers, above.
† #_#_# in the file name is the firmware version number.

Figure 1-2 Controller Firmware Version Numbers and File Names

1.8 Controller Password and Serial Number

The generator serial number and the controller password for the RDC2 or VSC controller are required for the OnCue Plus application.

Perform the password reset procedure before connecting the generator set's Ethernet cable to the router. If the generator set is connected to the Internet before the password is set at the controller, you will need to cycle power to the controller after setting the password.

Note: A new password is generated each time the reset password procedure is performed.

If the password is reset after the OnCue Plus system has been set up, the connection will be lost. Disconnect the battery power to the controller, wait a minute, and then reconnect the power. Re-enter the time, date, and exercise schedule on the controller after the power is reconnected.

1.8.1 RDC2 and VSC Controller Password and Serial Number

Be ready to write down the serial number and password. The serial number (S/N) and password are displayed for 10 seconds. Follow this procedure to obtain the serial number and password:

1. Press the controller's down arrow button to navigate to the Networking Information menu.
2. Follow the reset password procedure shown in Figure 1-3. See the generator set operation manual for more information, if necessary.
3. Write down the serial number (S/N) and password.

1.8.2 DC2 Controller Password and Serial Number

Be ready to write down the serial number and password. The serial number (S/N) and password are displayed for

10 seconds. Follow this procedure to set the OnCue Plus password on the DC2 controller:

1. Press the OFF button and verify that the generator set is not running.
2. Press and hold the Exercise button until Press Again to Reset OnCue Plus PW is displayed.
3. Release the Exercise button and press it again within 5 seconds.
Note: If the Exercise button is not pressed within 5 seconds, the controller exits the password reset mode.
4. Write down the serial number (S/N) and password.

1.8.3 RDC/DC Controller Password

The password may have been recorded during the installation of the Ethernet option board on the generator set controller. See TT-1566 or the procedure below.

Be ready to write down the password. The four-digit password will be displayed for 10 seconds. Follow this procedure to obtain the serial number and password:

1. Press the OFF button to place the controller into OFF mode.
2. Press the down arrow button (RDC) or exercise button (DC) 5 times. Note the four-digit code displayed on the controller. This is the controller password.
3. Write down the password to enter into OnCue Plus.
4. Press OFF to clear the display.

Note: Do not repeat this procedure after the password has been entered into OnCue Plus.

The controller password changes each time this procedure is performed. If the controller is connected to OnCue Plus and this procedure is performed again, the connection will be lost.

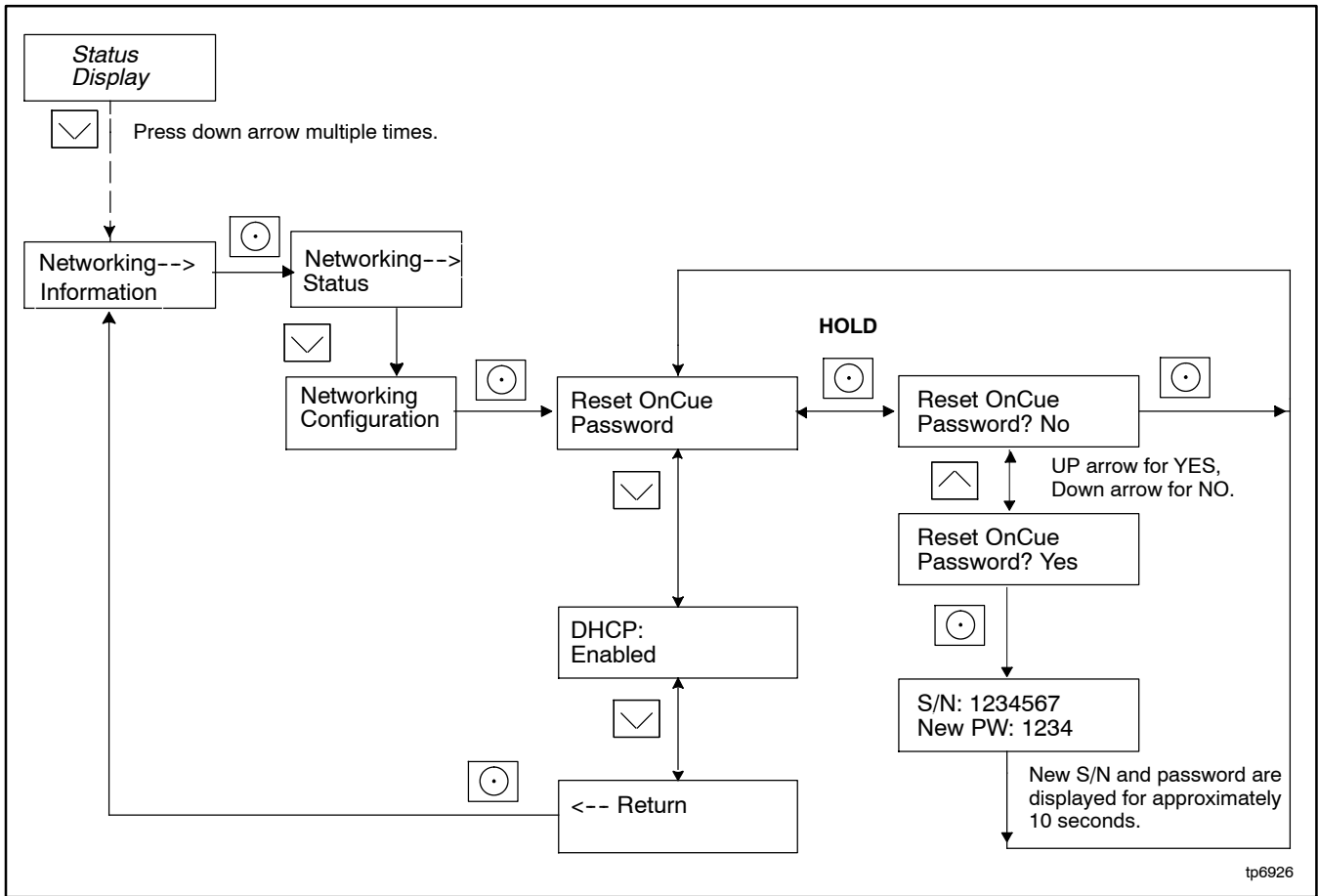

Figure 1-3 Finding the Serial Number and Password, RDC2 and VSC Controllers

1.8.4 Nameplate Serial Number

Verify that the serial number shown on the controller display matches the serial number on the generator set nameplate. A typical nameplate is shown in Figure 1-4. Refer to the service views in the generator Operation Manual for the location of the nameplate, if necessary. If the serial numbers on the controller display and the generator nameplate do not match, contact your distributor or dealer.

The activation code is only required the first time you connect a generator set to the OnCue Plus system. See Section 2.8.

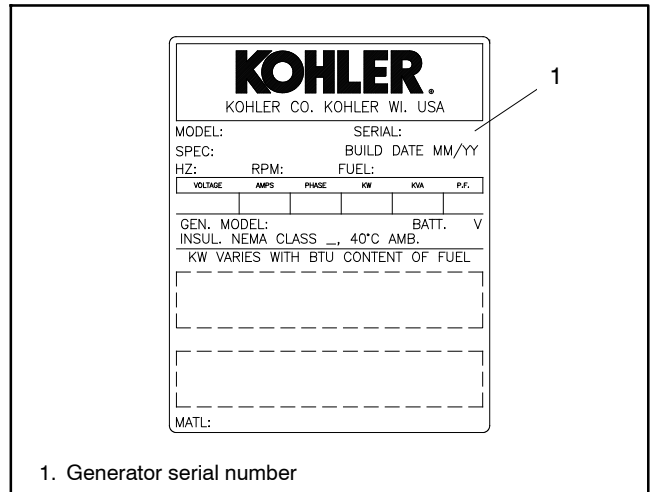

Figure 1-4 Generator Nameplate, Typical

1.8.5 Activation Code

The RDC2/DC2/VSC generator set controllers require a unique 12-digit activation code. The code is on the decal included with the OnCue Plus kit. See Figure 1-5.

Kohler OnCue Plus will prompt the user to enter the activation code the first time the controller connects to Kohler OnCue Plus Server and a user attempts to connect to it.

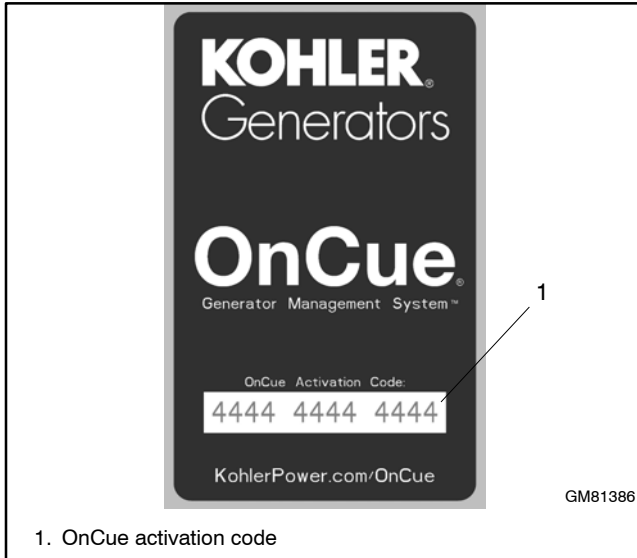

Figure 1-5 OnCue Activation Code Decal

1.9 Connect the Generator to the Internet

Note: Record the controller password and serial number from the controller as described in Section 1.8 **before** connecting the generator to the Internet.

⚠ WARNING



**Accidental starting.
Can cause severe injury or death.**

Disconnect the battery cables before working on the generator set. Remove the negative (-) lead first when disconnecting the battery. Reconnect the negative (-) lead last when reconnecting the battery.

Disabling the generator set. Accidental starting can cause severe injury or death. Before working on the generator set or equipment connected to the set, disable the generator set as follows: (1) Press the generator set off/reset button to shut down the generator set. (2) Disconnect the power to the battery charger, if equipped. (3) Remove the battery cables, negative (-) lead first. Reconnect the negative (-) lead last when reconnecting the battery. Follow these precautions to prevent the starting of the generator set by the remote start/stop switch.

1.9.1 OnCue Plus for RDC2/DC2/VSC

The RDC2, DC2, and VSC generator set controllers are equipped with an Ethernet cable for connection to the Internet. The Ethernet cable is connected to the controller and routed into the customer connection area inside the generator enclosure.

After setting the controller password, connect the RJ45 inline connector included in the OnCue Plus kit to the Ethernet cable inside the generator enclosure. See Figure 1-6 or the generator set installation manual. Then connect one end of the customer-provided network cable to the RJ45 connector, and connect the other end of the cable to the customer's router or modem. See Figure 1-7 or Figure 1-8.

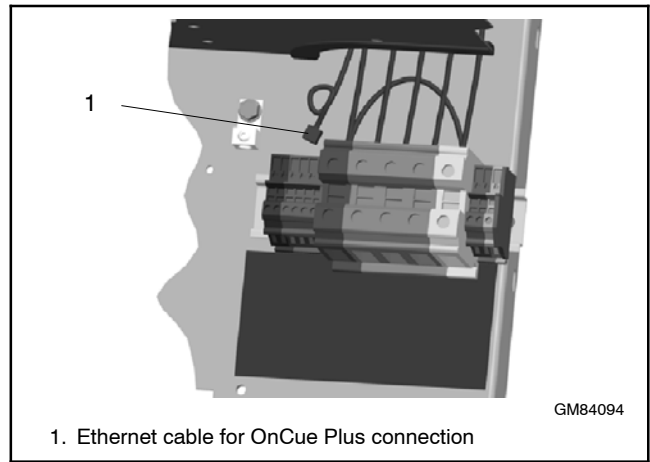

Figure 1-6 Ethernet Connection, RDC2/DC2 (Model 20RESA Shown)

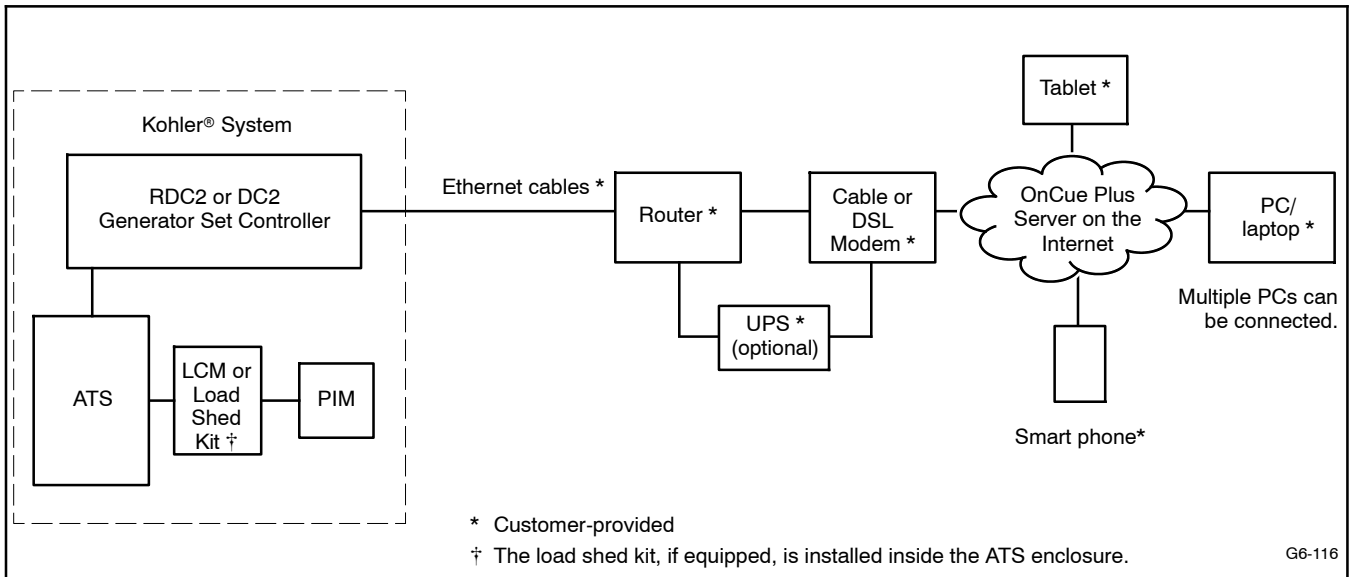

Figure 1-7 Typical Wired Connections for RDC2/DC2 Controller - OnCue Plus Kit

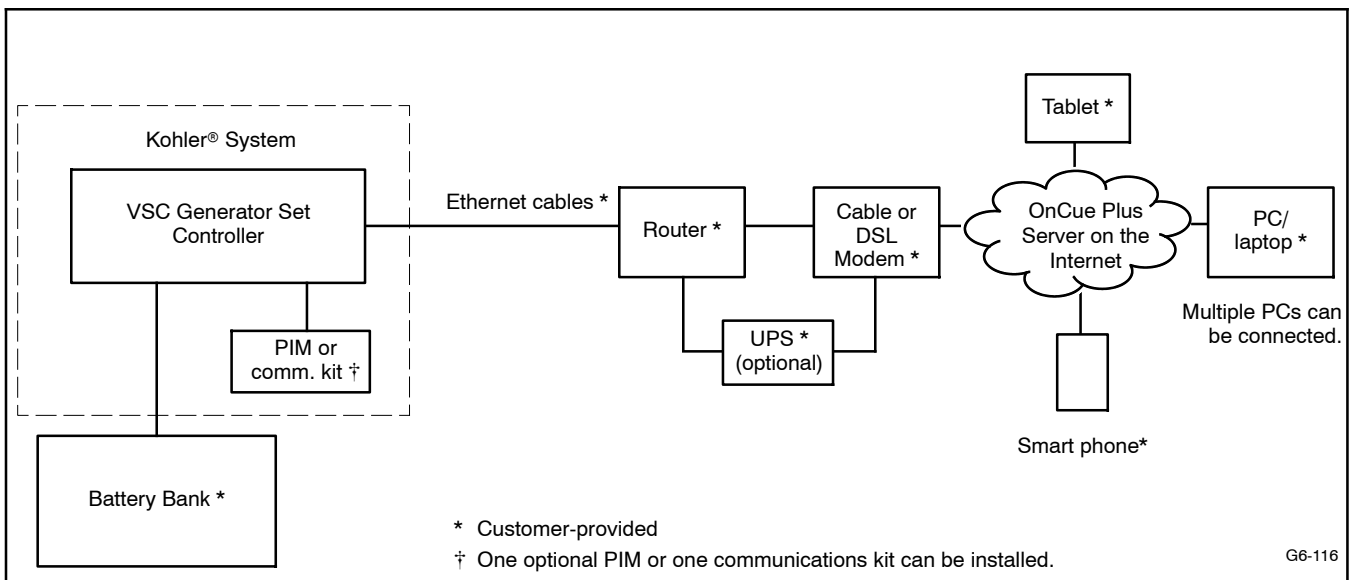

Figure 1-8 Typical Wired Connections for VSC Controller - OnCue Plus Kit

1.9.2 OnCue Plus Wireless for RDC2/DC2

The OnCue Plus Wireless kit allows connection of the generator to the customer's Ethernet router without running a network cable from the generator to the router. See Figure 1-10 for a typical wireless connection.

After setting the controller password, follow the instructions in TT-1618, provided with the OnCue Plus Wireless kit, to install, connect, and set up the wireless access point. The customer must have a wireless router for Internet access. See Figure 1-9 for a typical wireless access point installation inside the generator enclosure.

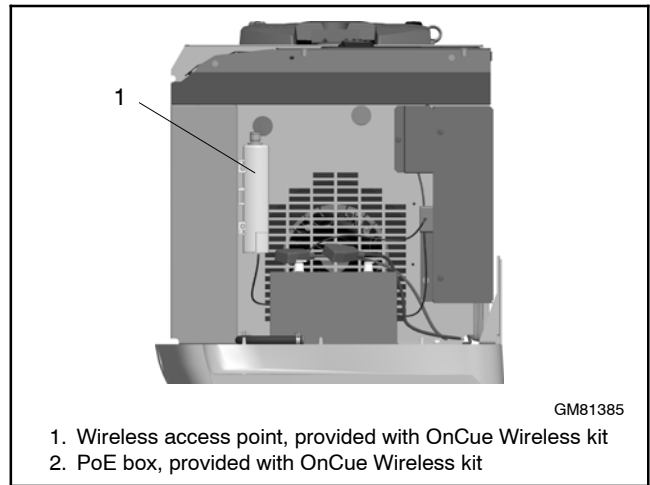

Figure 1-9 Typical OnCue Wireless Kit Installation, RDC2/DC2 (Model 20RESA Shown)

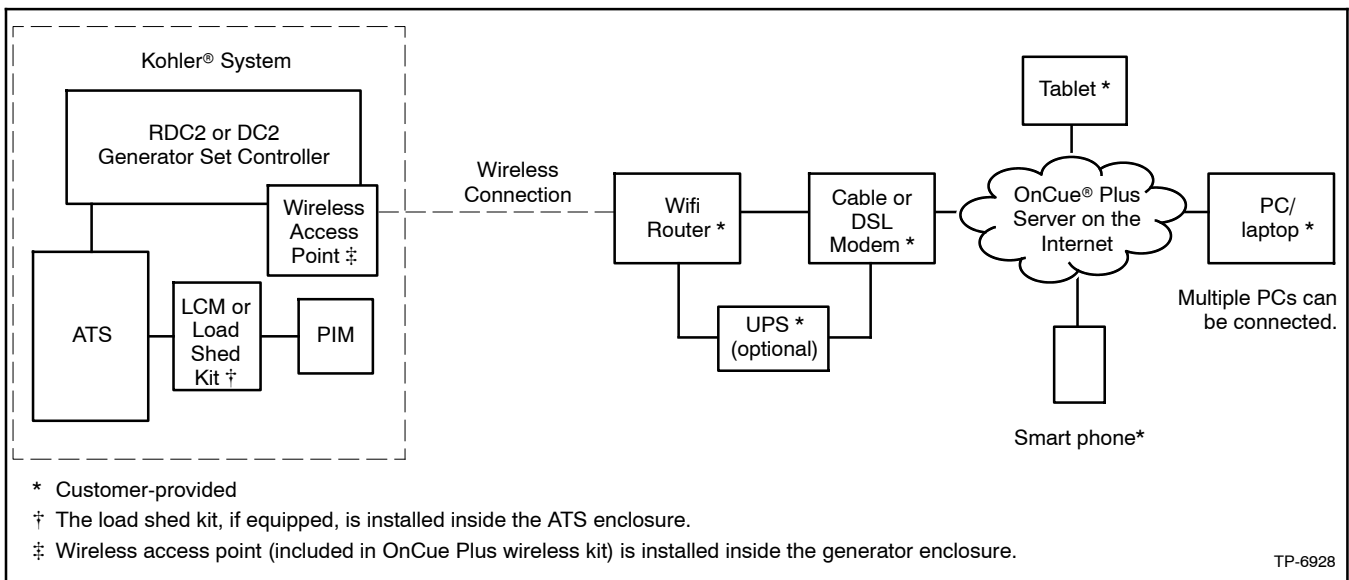

Figure 1-10 Typical Wireless Connections for RDC2/DC2 Controller - OnCue Plus Wireless Kit

1.9.3 RDC/DC Controller

The RDC/DC generator set controller must be equipped with the Ethernet option board, which allows connection of the generator set to the Internet through a broadband Internet connection. The Ethernet option board is included in the OnCue Plus and OnCue Plus Wireless kits for the RDC/DC controller. See instruction sheet TT-1566, included with the kits, for Ethernet option board installation and connection instructions.

When the Ethernet board is installed, update the RDC/DC controller firmware and follow the instructions in Section 1.8.3 or TT-1566 to record the controller password and generator set serial number for entry into the OnCue Plus application.

In most cases, once the new firmware is uploaded to the controller and the Ethernet board is connected to the

customer's router or modem, the controller will automatically connect to the Kohler OnCue Plus server. Controller settings and network router adjustments are usually not required. The Internet connection between the controller and the Kohler OnCue Plus server is fully encrypted for your protection.

1.9.4 OnCue Plus for RDC/DC

1. Install the Ethernet option board on the generator set controller. See TT-1566, provided with the OnCue® Plus kit, for instructions.
2. Connect the generator set to the Internet using a network cable connected from the Ethernet board to your router or modem.

See Figure 1-11 for typical OnCue Plus wired connections.

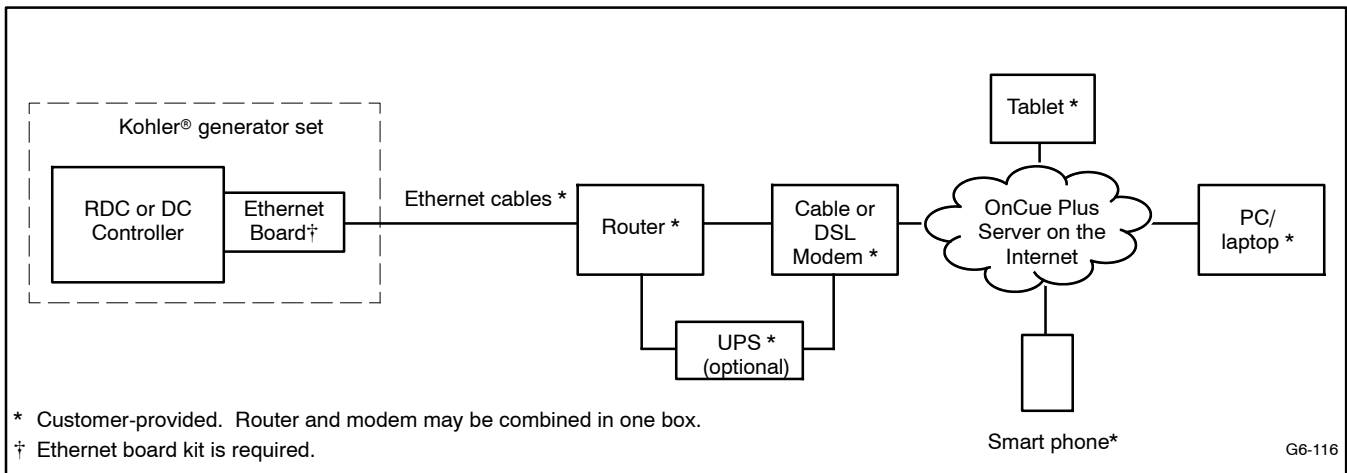

Figure 1-11 Typical Wired Connections for RDC/DC Controller - OnCue Plus Kit

1.9.5 OnCue Plus Wireless for RDC/DC

1. Install the Ethernet option board on the generator set controller. See TT-1566, provided with the OnCue® Plus kit, for instructions.
2. Follow the instructions in TT-1618, provided with the OnCue Plus Wireless kit, to install, connect,

and set up the wireless access point. The customer must have a wireless router for Internet access. See Figure 1-9 for a typical wireless access point installation inside the generator enclosure.

See Figure 1-12 for typical OnCue Plus Wireless connections.

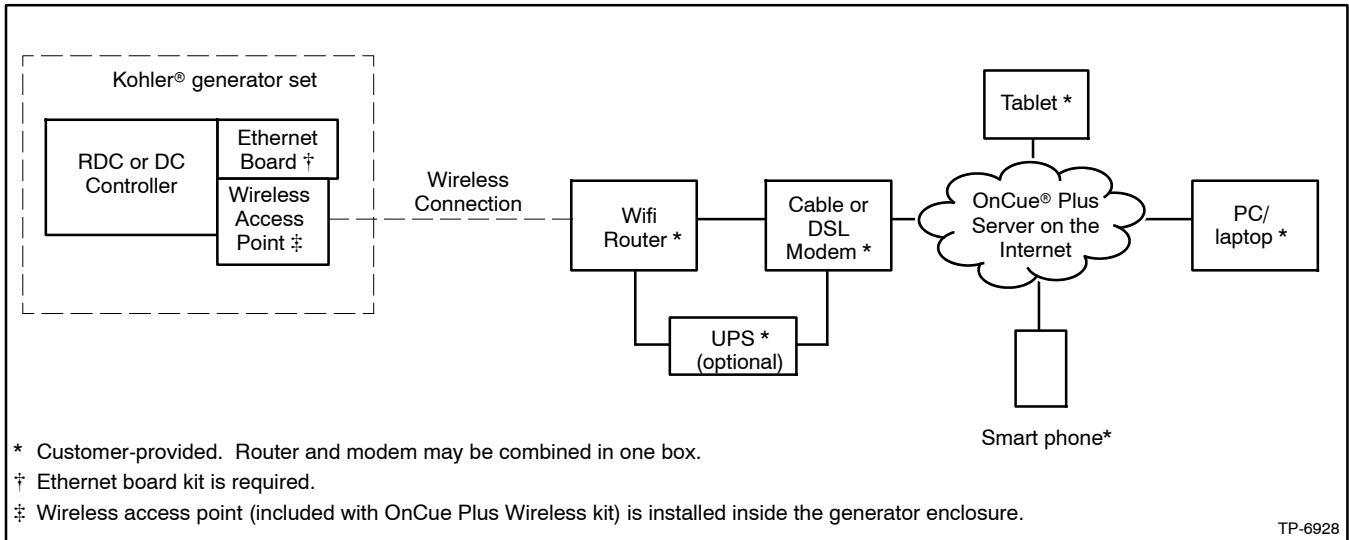

Figure 1-12 Typical Wireless Connections for RDC/DC Controller - OnCue Plus Wireless Kit

Section 2 OnCue Plus Operation

2.1 Introduction

Kohler® OnCue® Plus monitors the generator set and generates messages continually. After the application has been configured to send email and/or text messages, the OnCue Plus server will continue to send messages when the PC is turned off or disconnected from the Internet.

Note: Sample screens are shown in this document. The actual screens may vary.

OnCue Plus is available as a web version and as an app for Apple® and Android™ devices. For smart phones or tablets, obtain the Kohler OnCue Plus app from the App StoreSM (for Apple devices) or Google Play™ (for Android™ devices). App screens are similar to the web screens shown in this manual.

2.2 Information Required

You will need to enter some information when you create your OnCue Plus account and connect to your generator set. To set up an account, provide your full name and email address, and create a username and account password. To add a generator to the account,

you will need other information from the generator set and the OnCue Plus kit. Required information is listed in Figure 2-1.

2.3 Start OnCue Plus

- To use the OnCue Plus web application, use your computer to navigate to the OnCue Plus website www.kohlergenerators.com/oncue. The OnCue Plus log-in window opens. When you start OnCue Plus for the first time, click on Create Account. See Figure 2-2. Instructions in the following sections explain how to set up an account and add your generator to OnCue Plus.
- For smart phones or tablets, obtain the Kohler OnCue Plus app from the App StoreSM (for Apple devices) or Google Play™ (for Android devices). Follow the Quick Start instructions in the app to set up an account and add your generator to OnCue Plus. Operation of the app is similar to using the web application as described in this manual.

OnCue Plus will remember your generator set and connect to it each time you use OnCue Plus.

Item	Description	Set Up Account	Add Generator	Can Change in Settings View?
Full Name	Enter your full name when setting up your account.	•		NO
Username	Create your username when setting up your account.	•		NO
Email Address	Enter your email address when setting up your account.	•		NO
Password	Create a password when setting up your account.	•		NO
Serial Number	For adding new generator, get from genset controller nameplate or controller. See Section 1.8.		•	NO
Genset Password	For adding new generator, get from genset controller. See Section 1.8.		•	YES
OnCue Plus Activation Code	From OnCue decal, provided with OnCue Plus kit. See Section 2.8.		•	NO
Genset Displayname	Create a name that identifies the generator set.		•	YES
Genset Location	Enter address or other location information for the generator set.		•	YES

Figure 2-1 Required Information

Apple, the Apple logo, iPhone and iPad are registered trademarks of Apple Inc., registered in the U.S. and other countries. App Store is a service mark of Apple Inc.

Android and Google Play are trademarks of Google Inc.

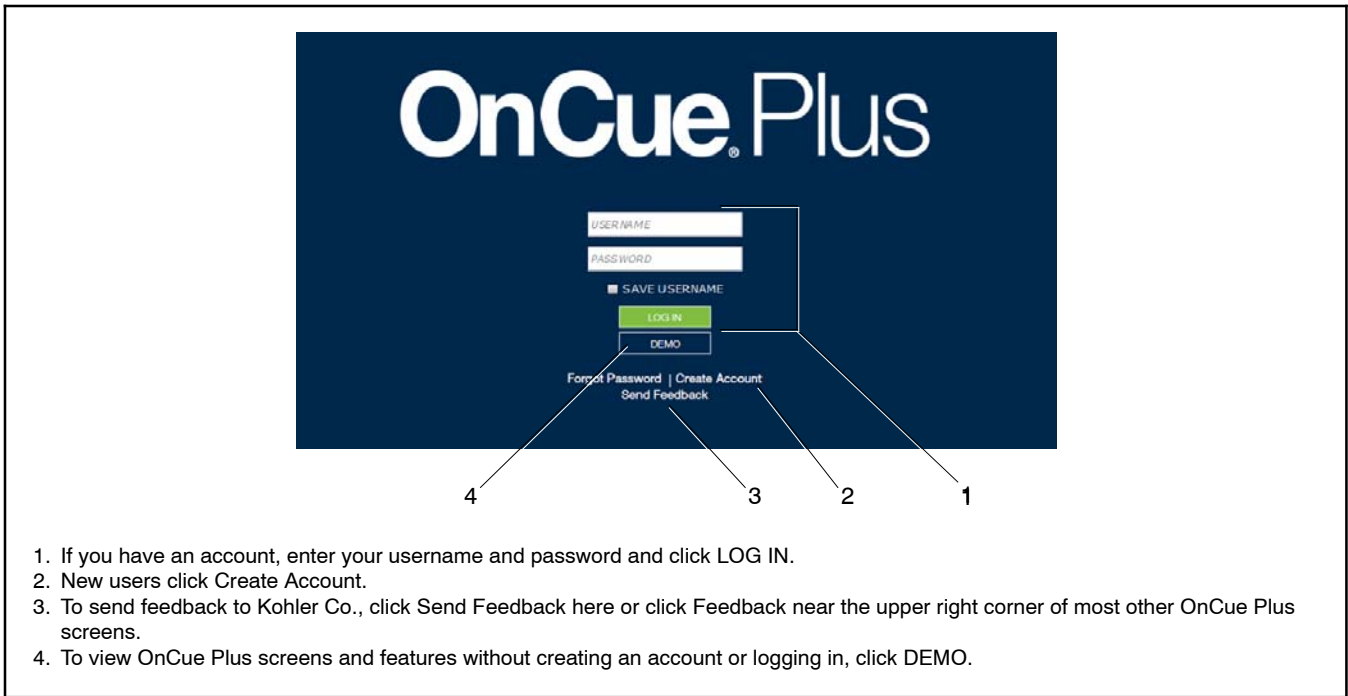

Figure 2-2 OnCue Plus Sign In Screen

2.4 DEMO Button

To preview the OnCue Plus screens and operation without creating an account or logging in, click on the DEMO button. See Figure 2-2. The demo allows you to navigate through all menus and review the information available through OnCue Plus without connecting to an actual generator set. You can “start” and “stop” the demo generator set from the Controls menu, view the generator parameters, and rename inputs and outputs.

2.5 Send Feedback Button

Click on the Send Feedback button in the Sign-In Screen or click on the Feedback command in the upper right corner of other screens to send your comments to Kohler Co. The screen shown in Figure 2-3 will open.

Touch or click on the relevant feedback topic and follow the instructions on the screen.



Figure 2-3 Feedback Window

2.6 Create an Account

The first time that you use OnCue Plus, you will need to set up an account. A user name, email address and password will be required. Create a username with 6 to 25 characters (no spaces) and a password for your account, and keep them in a safe place.

Click on Terms of Service near the bottom of the screen and read the OnCue terms and conditions of use. Then

click on the box next to “I accept the OnCue Plus terms and conditions of use” to indicate your acceptance of the OnCue terms and conditions of use.

Click on Create Account.

An email will be sent to the email address given for the account. Follow the instructions in the email to activate your account. Internet access is required to activate your account.

The screenshot shows a mobile application interface for creating an account. At the top right, it says "CREATE ACCOUNT". Below this is a series of input fields: "Full Name*", "Username*", "Email Address*", "Password*", "Confirm Password*", "Address", "City", "State", and "Zip Code". Below the fields is a "Terms of Service" section with a checkbox and the text "I accept the OnCue Plus terms and conditions of use." At the bottom center is a "CREATE ACCOUNT" button. A large, diagonal "SAMPLE" watermark is overlaid across the entire form area.

Figure 2-4 Create an Account

2.7 Add New Generator

In order to monitor and control a generator using OnCue Plus, you must add the generator to your OnCue Plus account. Multiple generators can be added to one account. If you own more than one generator set, or if you are a dealer monitoring numerous customer

systems, you may add them to your account using this screen.

Click on ADD NEW GENERATOR as shown in Figure 2-5. The generator set serial number and controller password are required. See Section 1.8 for instructions to obtain the serial number and password.

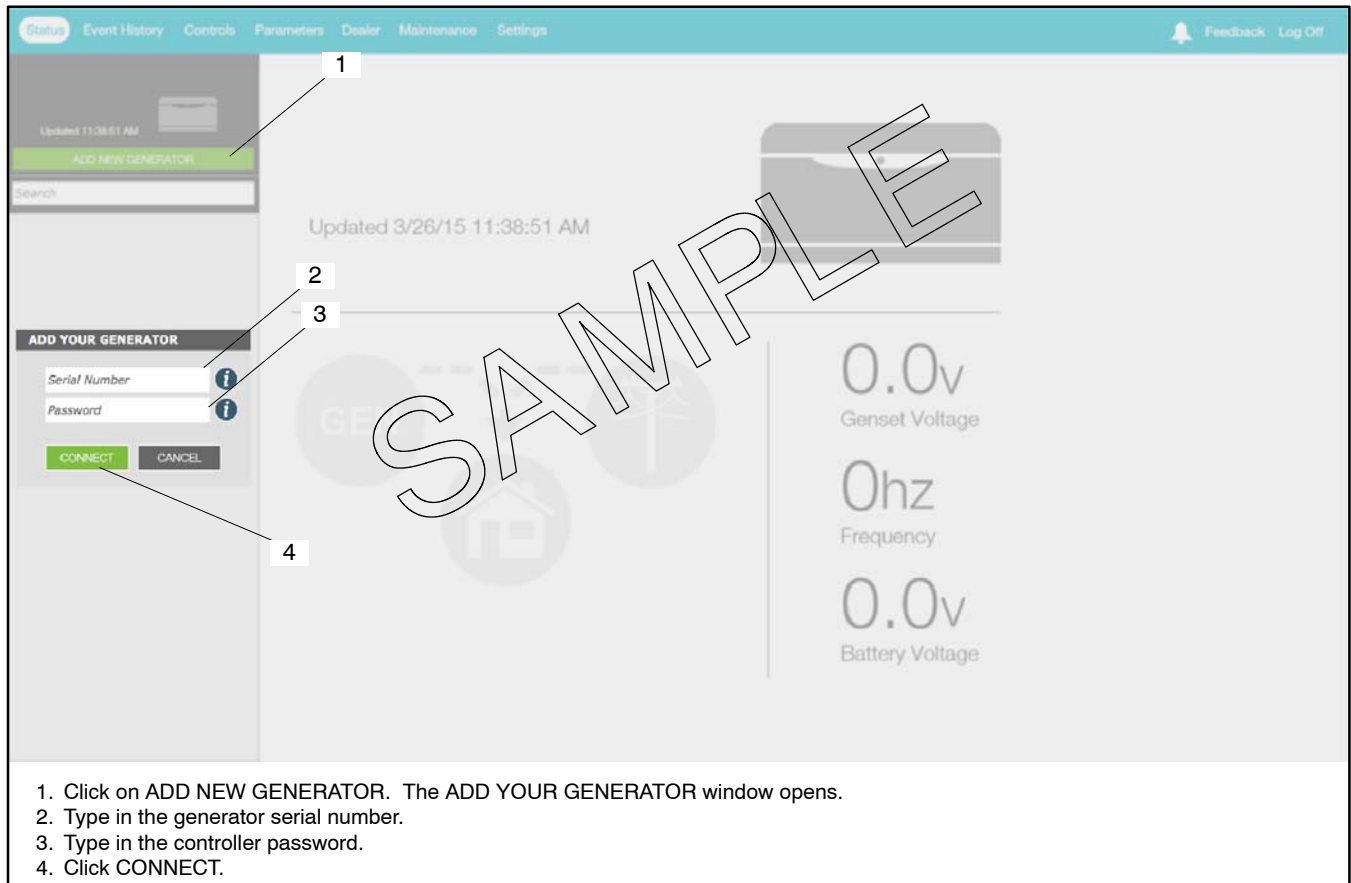

Figure 2-5 Add New Generator

2.8 Activate Your Generator

To authorize remote monitoring of your generator set, you will need the generator set serial number, OnCue activation code (not required for RDC/DC controllers), and controller password. Obtain the serial number from the controller when setting the controller password as described in Section 1.8, or find the serial number on the generator set's nameplate.

Find the activation code on the decal provided with OnCue Plus. See Figure 2-6. Attach the OnCue activation code decal to the generator set.

In the generator selection list on the left side of the screen, click on Activate Your Generator. See Figure 2-7. Then type your activation code into the Activate Generator window shown in Figure 2-8 and click on Activate.

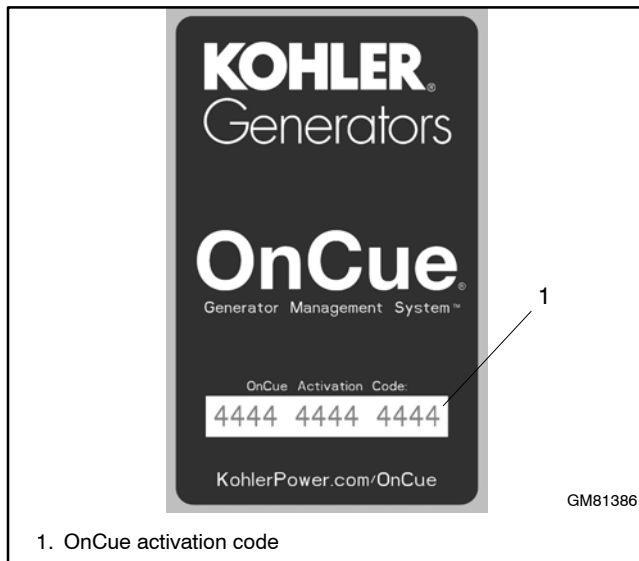

Figure 2-6 OnCue Activation Code Decal

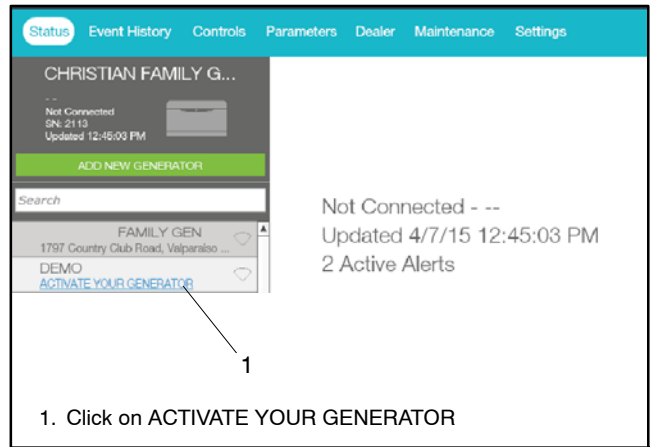

Figure 2-7 Activate Your Generator

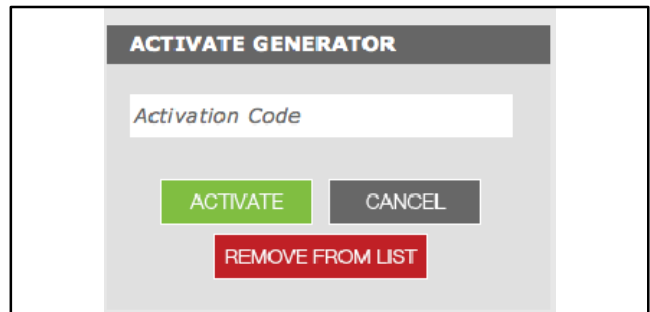

Figure 2-8 Activate Generator

2.9 OnCue Plus Views

OnCue Plus opens in the Status view. The following views are available:

- Status
- Event History
- Controls
- Parameters
- Dealer
- Maintenance
- Settings

To select a view, click on the desired view in the toolbar near the top of the screen. The selected view is highlighted in the toolbar. See Figure 2-9.

2.10 Status

The status screen is shown in Figure 2-9.

Symbols in the generator list on the left side of the screen indicate the status of each generator set. See Figure 2-10. The symbol to the left of the generator name indicates whether the generator is running, on standby, shut down, or turned off. See Figure 2-11 for illustrations and definitions of the symbols. The symbol to the right of the generator name shows whether the generator is connected to the OnCue Plus Server. If the symbol indicates no connection, see Section 3 for troubleshooting instructions.

See Figure 2-12 for an explanation of symbols and information displayed in the body of the Status screen.

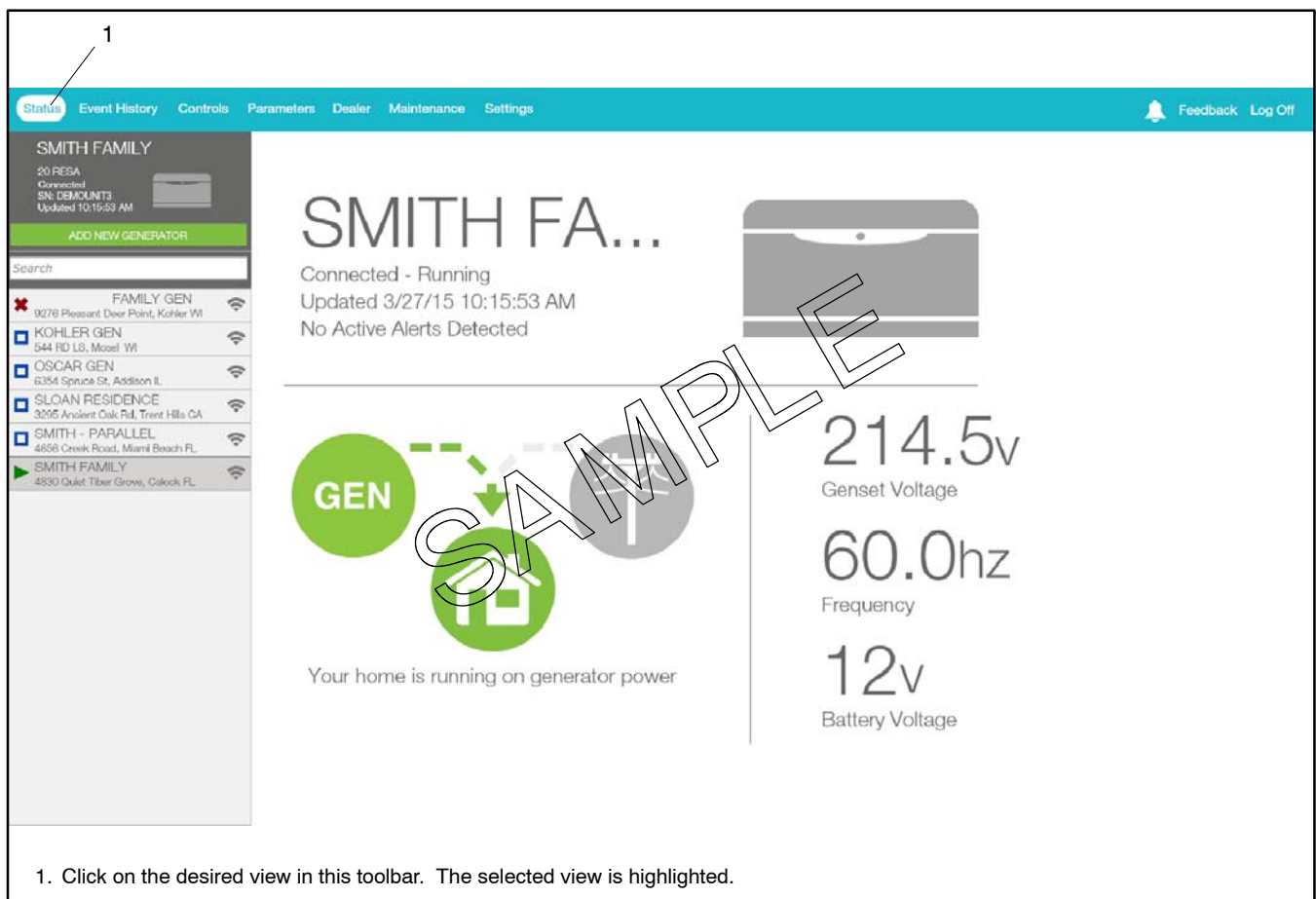

Figure 2-9 Power System Status

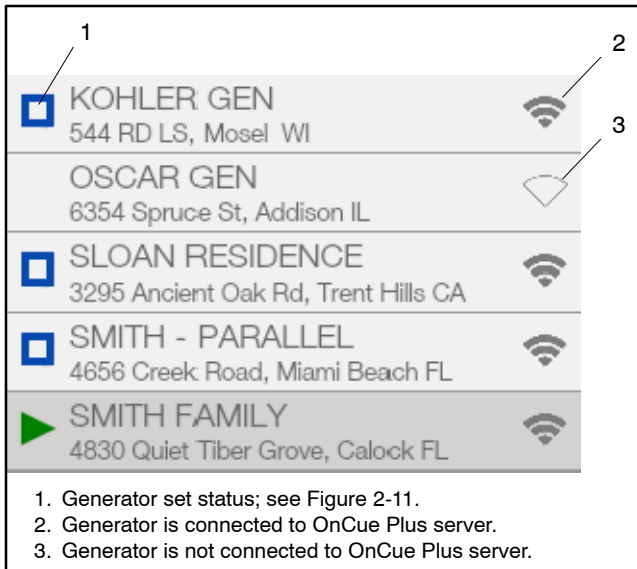

Figure 2-10 Generator Set Status and Connection Indicators

Indicator		Status	Description
	Blue square	Standby	Generator set is ready to start.
	Green triangle	Cranking or running	Engine is starting or running.
	Red X	Fault shutdown	The controller has detected a fault condition and the generator set has shut down.
	Red circle	Off	Controller is OFF.
	Connection symbol	Connected	Generator set is connected to the OnCue Plus server.
	Open symbol	Not Connected	Generator set is not connected to the OnCue Plus server.

Figure 2-11 Generator Set Status Indicators

Status Screen Item	Indicates	Notes
Name	Name of generator that you are monitoring	Select the generator from the list on the left side of the screen. (Click on the arrow symbol to reveal the list.)
Generator status message	The status of the generator that you have selected	Examples of status messages are “Generator Running” and “Standby.” If a fault condition is indicated, check the Event History view or the controller display to identify the fault.
Updated	The last time that generator information was updated in OnCue Plus	The frequency of updates can be changed through the Settings screen.
GEN symbol	Generator Status	Green when active, gray when not available.
Power line symbol	Utility power status	Green when active, gray when not available.
Home symbol and home status message	Home does or does not have power	Symbol is green when the home has power from either the generator or utility.
Genset Voltage	Output voltage from the generator set.	Displays voltage when the generator is running.
Frequency	Frequency of the generator set output.	Displays frequency when the generator is running. Nominally 50 or 60 Hz.
Battery Voltage	Generator engine starting battery voltage	Typically 12-15 volts DC. A voltage below 12.5 VDC will trigger a low battery voltage warning, indicating that the battery should be charged or replaced. A voltage less than 12 volts DC will be displayed in red.

Figure 2-12 Status Screen Displays

2.11 Select Generator

Kohler distributors and dealers may monitor more than one generator set for their customers. In the Status view, click on the arrow on the left side of the screen to reveal the list of generators that have been added to your account. All generator sets that you have added to your account will appear in a list on the left side of the screen. Scroll down if necessary and click on the

generator that you want to monitor. The selected generator set is displayed at the top of the list and also displayed in the Status view.

If you have multiple generator sets in your account, keep the list open to identify the selected generator set.

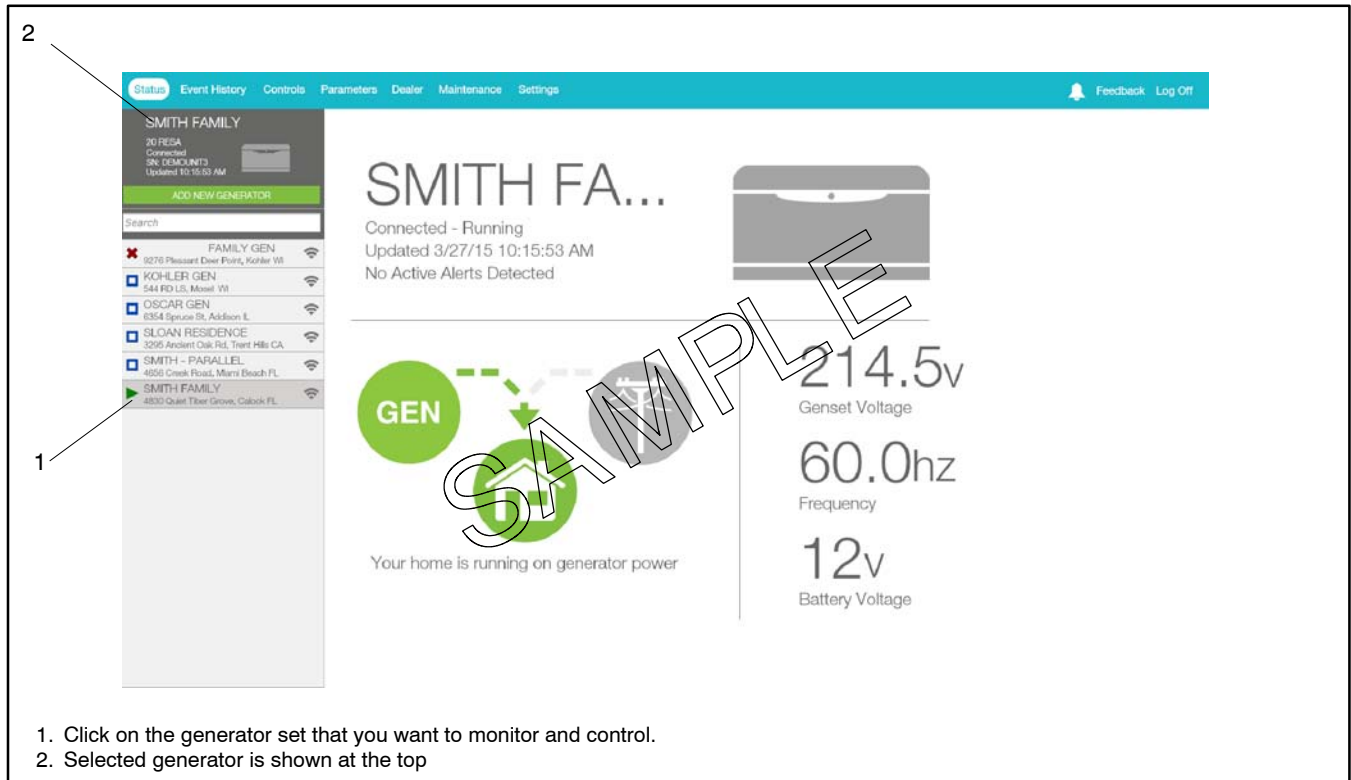

Figure 2-13 Select Generator

2.12 Event History

Click on Event history to view recent activity on your generator. The controller hours for recent generator operation, including exercise runs or other generator set starts and stops, are displayed. Generator fault conditions including warnings and shutdowns are also displayed.

Click on Clear Active to clear the active fault conditions. Contact your local dealer or distributor for service if fault conditions continue to appear.

If you would like more information about a particular event, please click/touch that particular event to bring up the event details screen. See Figure 2-16 for information contained on the event details screen. Click on the arrow near the upper left corner of the Details screen to return to the previous screen.

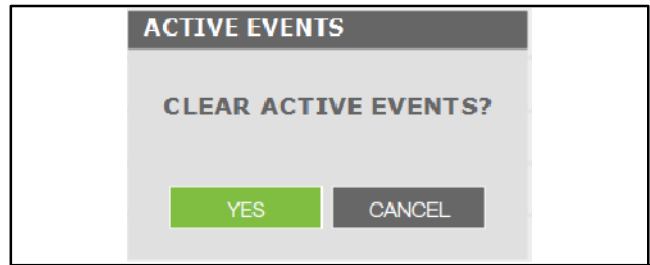
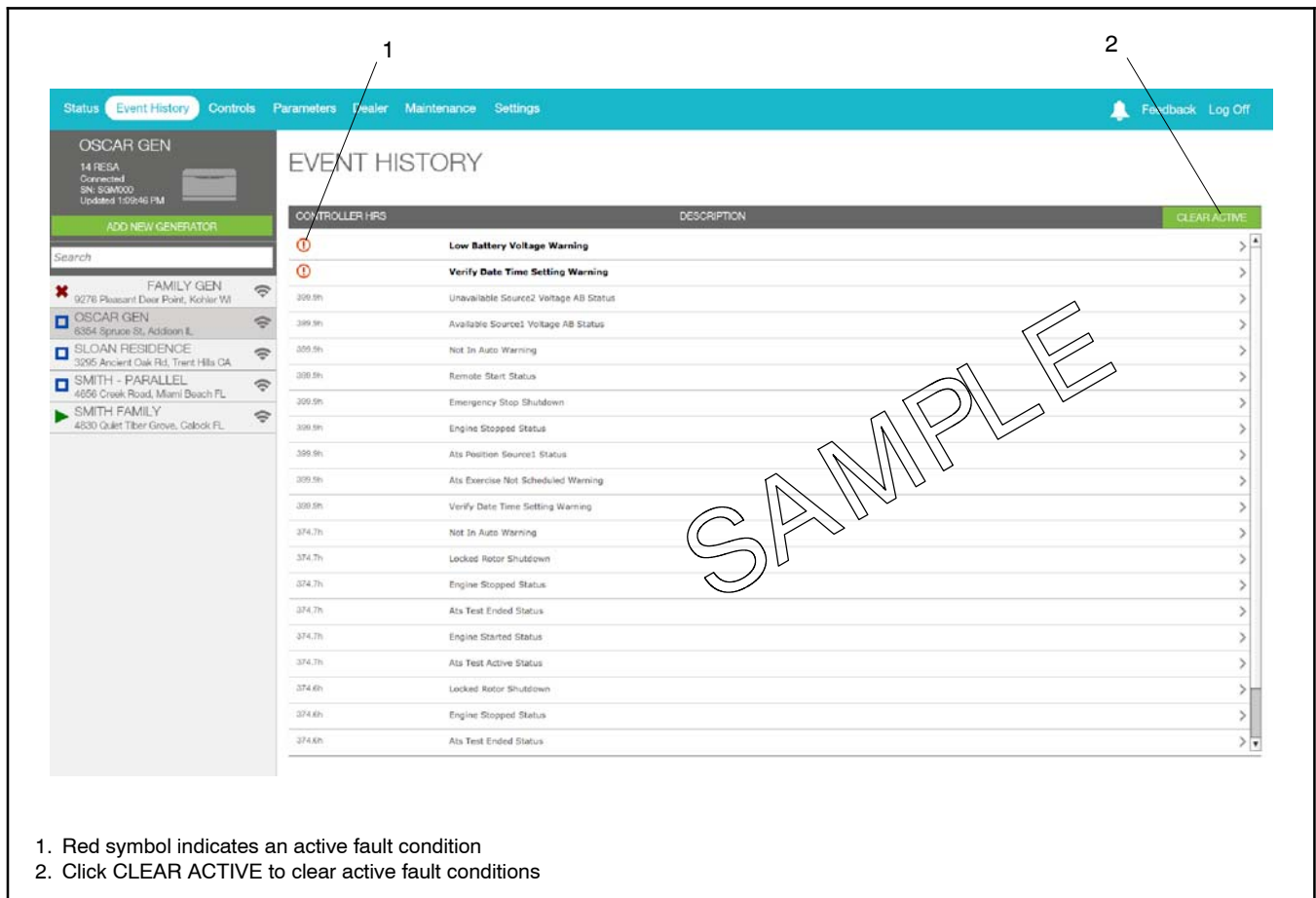

Figure 2-14 Clear Active Events Confirmation



CONTROLLER HRS	DESCRIPTION	CLEAR ACTIVE
309.9h	Low Battery Voltage Warning	
309.9h	Verify Date Time Setting Warning	
309.9h	Unavailable Source2 Voltage AB Status	
309.9h	Available Source1 Voltage AB Status	
309.9h	Not In Auto Warning	
309.9h	Remote Start Status	
309.9h	Emergency Stop Shutdown	
309.9h	Engine Stopped Status	
309.9h	Ats Position Source1 Status	
309.9h	Ats Exercise Not Scheduled Warning	
309.9h	Verify Date Time Setting Warning	
374.7h	Not In Auto Warning	
374.7h	Locked Rotor Shutdown	
374.7h	Engine Stopped Status	
374.7h	Ats Test Ended Status	
374.7h	Engine Started Status	
374.7h	Ats Test Active Status	
374.6h	Locked Rotor Shutdown	
374.6h	Engine Stopped Status	
374.6h	Ats Test Ended Status	

1. Red symbol indicates an active fault condition
2. Click CLEAR ACTIVE to clear active fault conditions

Figure 2-15 Event History

1

SMITH FAMILY
20 RESA
Connected
SN: DEMOUNT3
Updated: 12:56:42 PM

ADD NEW GENERATOR

Search

- FAMILY GEN
9276 Pleasant Deer Point, Kohler WI
- KOHLER GEN
544 RD LS, Mosel WI
- OSCAR GEN
8804 Spruce St, Addison IL
- SLOAN RESIDENCE
3295 Ancient Oak Rd, Trent Hills CA
- SMITH - PARALLEL
4656 Creek Road, Miami Beach FL
- SMITH FAMILY
4830 Quiet Tiber Grove, Calock FL

DETAILS

Event Name	Available Source2 Voltage AB Status
Event Time	03-26 1:18 PM
Event Level	1
Controller Hours	17684.3
Engine Run Time	322.3
Old Value	
New Value	
Parameter Name	Source2 Voltage AB

1. Back arrow returns to previous screen.

Figure 2-16 Event Details

2.13 Controls

From the Controls view, you can:

- Start and stop a generator exercise
- View the status of outputs connected to the PIM or LCM
- Turn outputs connected to the PIM on and off.

The generator set controller must be in AUTO mode for remote start/stop using OnCue Plus.

2.13.1 Start Exercise

To start an exercise, click Start in the Controls screen. The dialog box shown in Figure 2-17 opens. Click on START to confirm you want to start the generator set or CANCEL to exit and not start an exercise.

The exercise runs for 20 minutes (default setting) and then stops. Use the Stop Exercise command to stop the generator earlier, if necessary.

Exercise runs started through this command are unscheduled. Starting and stopping the engine using these commands does not change the exercise schedule on the generator set.

The exercise mode and duration can be changed through the maintenance screen. See Section 2.16.

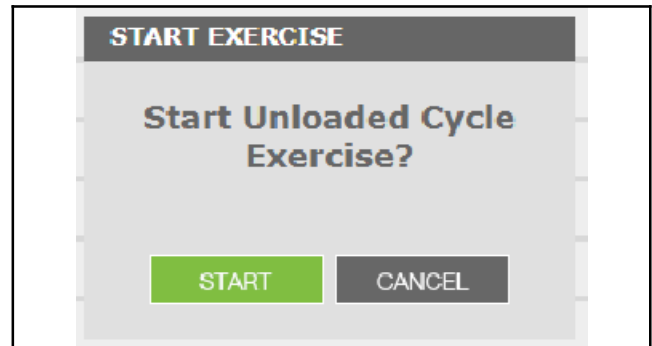

Figure 2-17 Select Exercise Type

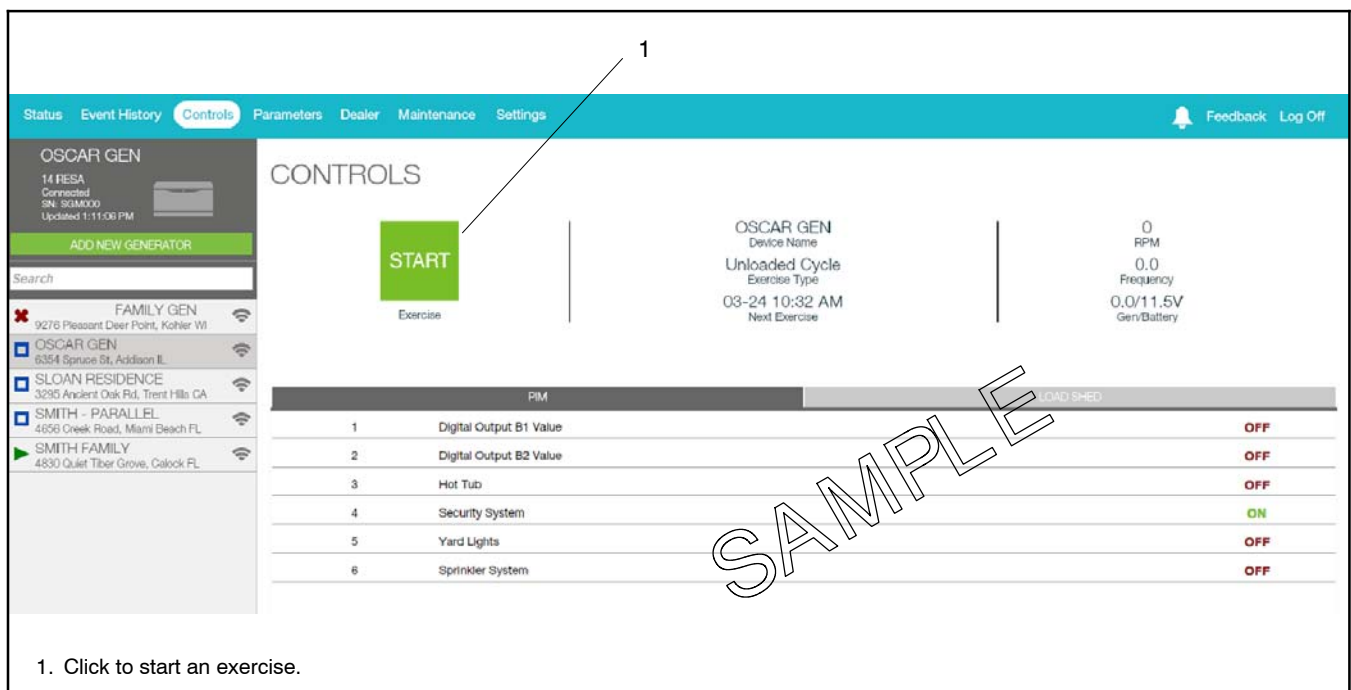

Figure 2-18 Controls, Start Exercise

2.13.2 Stop Exercise

After starting the engine using the Start button, click on Stop in the Controls screen to stop the engine before the programmed stop time, if necessary. Then confirm by clicking on YES in the STOP GENERATOR window that appears in the center of the screen. See Figure 2-19.

The generator set controller must be in AUTO mode for remote start/stop using OnCue Plus.

Note: The Stop Exercise command will not stop the generator set if it was started at the controller by pressing RUN, by a remote start command from an ATS, or by a scheduled exercise set at the controller.

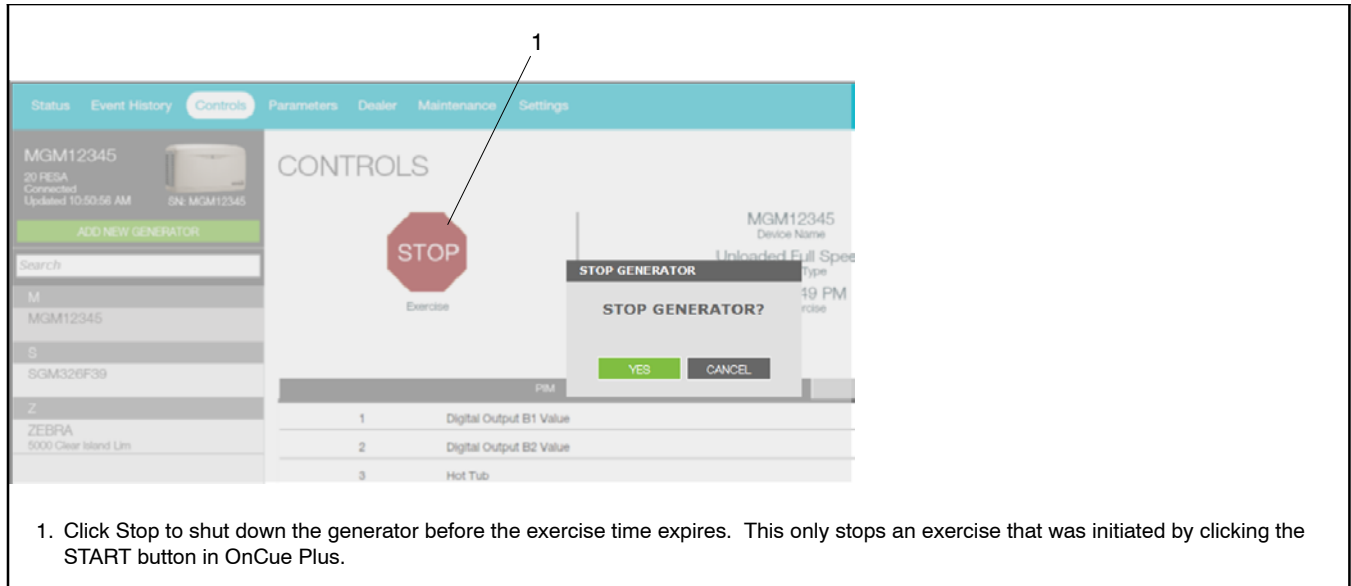

Figure 2-19 Controls, Stop Exercise

2.13.3 PIM

OnCue® Plus allows remote control of items in your home. Controlling items remotely requires an installed and properly connected Programmable Interface Module (PIM). The programmable interface module (PIM) is available for purchase as an optional kit.

Electrical items such as appliances, outdoor lighting, storm shutters, etc. can be connected to outputs on the PIM and then turned on and off using OnCue Plus through your personal computer, smart phone, or tablet with Internet access.

The PIM provides two programmable inputs and six programmable outputs for connection to customer-supplied equipment. The PIM operates only with generator sets equipped with the Kohler RDC2, DC2, or VSC controller. See TT-1584 for PIM installation and setup instructions.

Note: PIM outputs 1 and 2 are factory-set to Generator Running and Common Fault. Outputs 1 and 2 cannot be controlled remotely through OnCue® Plus.

Use the Controls screen to remotely control items in your home connected to outputs 3 through 6.

1. Select the Controls screen in the OnCue Plus Toolbar.
2. Click on the tab labeled PIM.
3. Click on the name of the output to turn it on or off. The status indicator (ON/OFF) flashes for approximately 5 seconds before changing to the new status.

Once OnCue Plus is used to turn a PIM output on or off, the output will no longer be controlled by the generator set. For example, output 4 may initially be set to the Engine Oil Low Pressure Warning. If OnCue Plus is used to turn that output on or off, the output will no longer turn on when the generator's low oil pressure warning is activated. The output must be operated through OnCue Plus.

Use OnCue Plus to rename the output functions to identify the equipment connected to each output. See Section 2.17, Settings, for label renaming instructions.

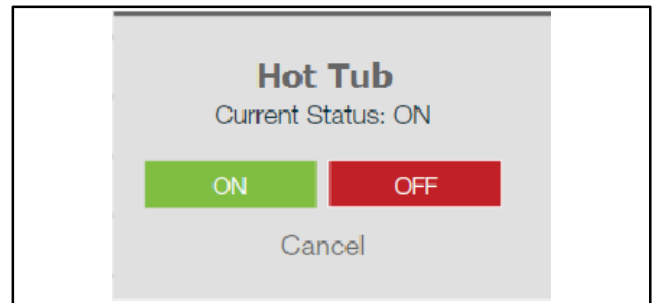

Figure 2-20 Manual Management

2.13.4 Load Shed

Click on the Load Shed tab in the Controls screen to see the status of items connected to the load control module (LCM) or load shed kit. Non-essential loads connected to the load control relays are disconnected automatically when essential equipment is running to prevent generator set overload.

The item descriptions can be edited through the Settings view. See Section 2.17.

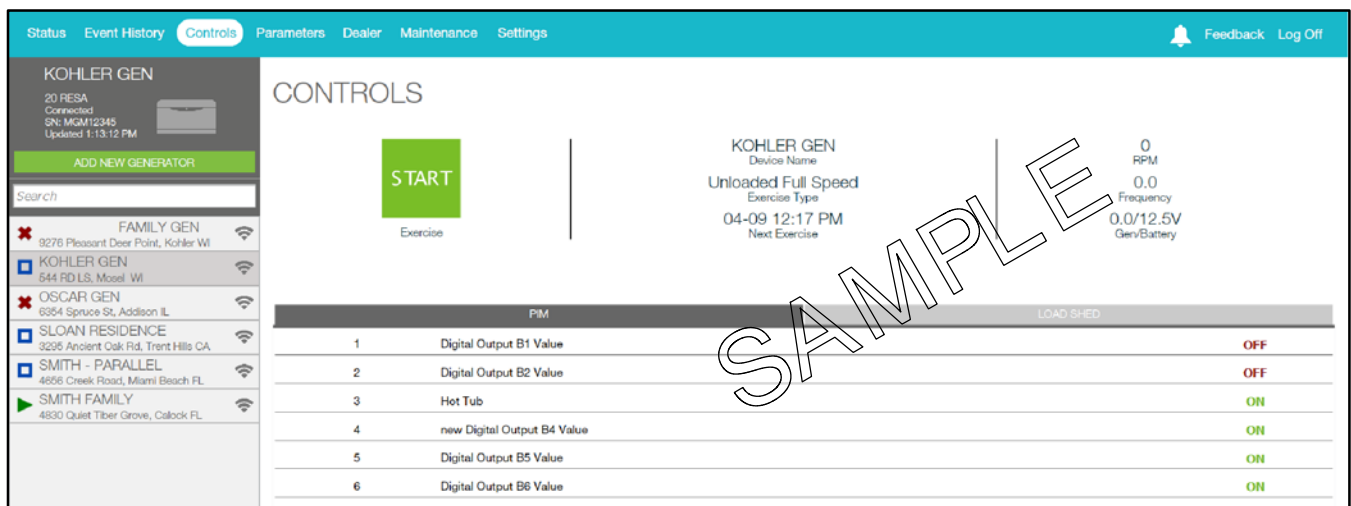

Figure 2-21 Controls, PIM

2.14 Parameters

The parameters shown in Figure 2-22 can be viewed from this screen. To change generator settings, go to the Settings tab and see Section 2.17.

Power

Total power and percent of rated power are displayed only for the following generator set models:

- 10RESV
- 12RESV
- 38RCL
- Two 14RESAs paralleled using the PowerSync™ APM
- Two 20RESAs or 20RESBs paralleled using the PowerSync™ APM

The screenshot shows the 'PARAMETERS' screen for the 'SMITH FAMILY' generator. The left sidebar lists several generator units, with 'SMITH FAMILY' selected. The main area displays a table of parameters for this unit.

Name	Value
Product	Rdc2
Firmware Version	5.10.0
Engine Speed	3599R/min
Engine Oil Pressure	0 Psi
Engine Coolant Temperature	32 °F
Battery Voltage	12V
Lube Oil Temperature	147.2 °F
Genset Controller Temperature	104 °F
Engine Compartment Temperature	32 °F
Generator True Total Power	0.0W
Generator True Percent Of Rated Power	0%
Generator Voltage Average Line To Line	214.5V
Generator Frequency	60.0Hz
Genset State	Running
Genset Controller Clock Time	2015-03-26 07:40:38
Genset Controller Total Operation Time	17878.7h
Engine Total Run Time	321.9h
IPAddress	0.0.0.0
Connected Server IPAddress	12.31.102.157
Network Connection Established	True

Figure 2-22 Parameters

2.15 Dealer Communication

2.15.1 Enter Dealer Information

Use the Settings view to enter your dealer's information before using the Dealer feature. See Section 2.17, Settings.

2.15.2 Email Your Dealer

Clicking on the EMAIL command will open the email application on your device and open a new email addressed to your dealer. Type in your message and send.

The OnCue Plus App on your smart phone or tablet will also allow you to call your dealer from this screen.



Figure 2-23 Dealer

2.16 Maintenance

Click on Maintenance to see the total run time on your generator and exercise information.

2.16.1 Hours

The total generator engine runtime is shown in hours near the top of the maintenance screen.

2.16.2 Manage Exercise Details

Click on MANAGE in the upper right corner of the Maintenance screen to change the exercise settings for the generator. Refer to the generator documentation for recommended exercise settings. The following settings can be changed:

Exercise Interval

Use the drop-down arrows to select weekly or every other week.

Exercise Run Duration

Choose how long the generator will run during exercise. Use the drop-down arrows to select from 10 to 30 minutes. 20 minutes is the default setting and is typically the minimum recommended duration.

Exercise Mode

Use the drop-down arrows to select the exercise mode.

- **Unloaded Full-Speed Exercise.** Runs the generator set at full speed without transferring the load from utility. The model VSG generator set runs at rated no-load speed.
- **Unloaded Cycle Exercise.** Runs the unloaded cycle exercise with complete system diagnostics. See generator set Operation Manual for information about the unloaded cycle exercise and diagnostics.
- **Loaded Full-Speed Exercise.** Runs the generator set at full speed and transfers the load from utility to the generator. At the end of the exercise cycle, the load is transferred back to utility before the generator stops.

EXERCISE INFO		MANAGE
Exercise Start Time		Not Scheduled
Last Exercise		Not Scheduled
Next Exercise		Not Scheduled
Exercise Interval		Every Other Week
Exercise Duration		24 Minutes
Exercise Mode		Unloaded Full Speed

Figure 2-24 Maintenance

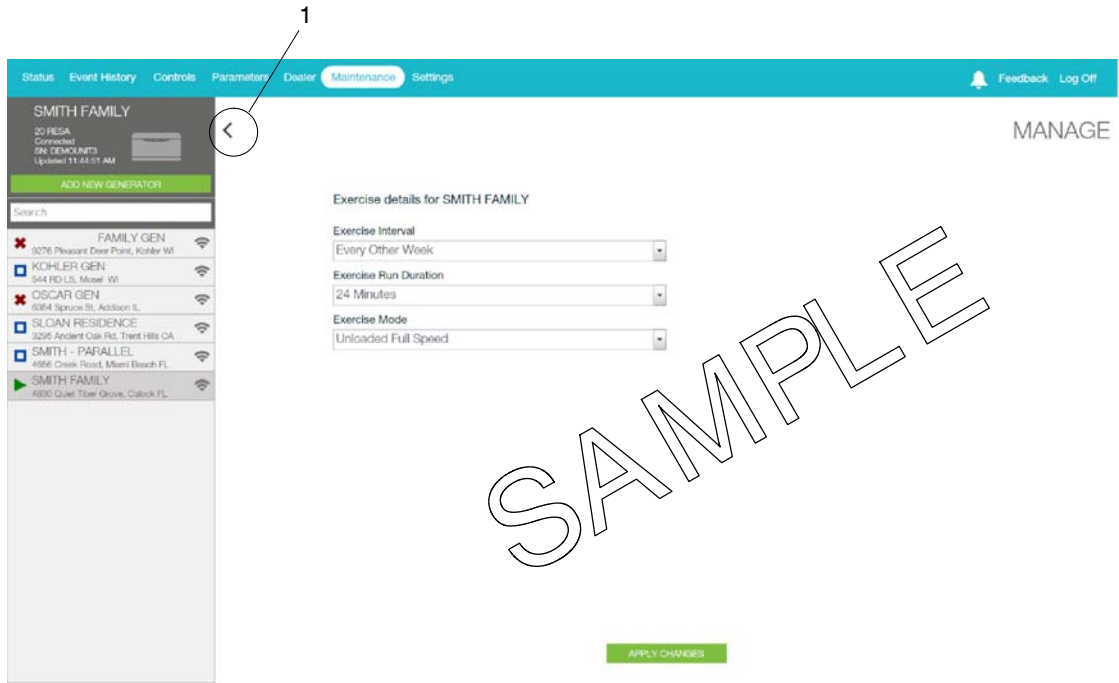

1. Back arrow returns to previous screen.

Figure 2-25 Manage Menu for Exercise Settings

2.17 Settings

Use the Settings view to set up email and text notifications, and also to change system settings, including the frequency of generator data updates and the labels on the PIM and load shed outputs. See Figure 2-26. This view also contains a Delete command that allows you to remove a generator from your list of monitored generators.

2.17.1 Add or Delete Email Recipients

To set up email notifications, click NEW to the right of Email Notification Recipients in the settings view. See Figure 2-26. In the Add Email Recipient view, type the recipient's name and email address. Click SAVE. See Figure 2-27.

To remove an email address from the list, click EDIT to the right of the address to be deleted. Then click DELETE at the bottom of the Edit Email Recipient screen. See Figure 2-29.

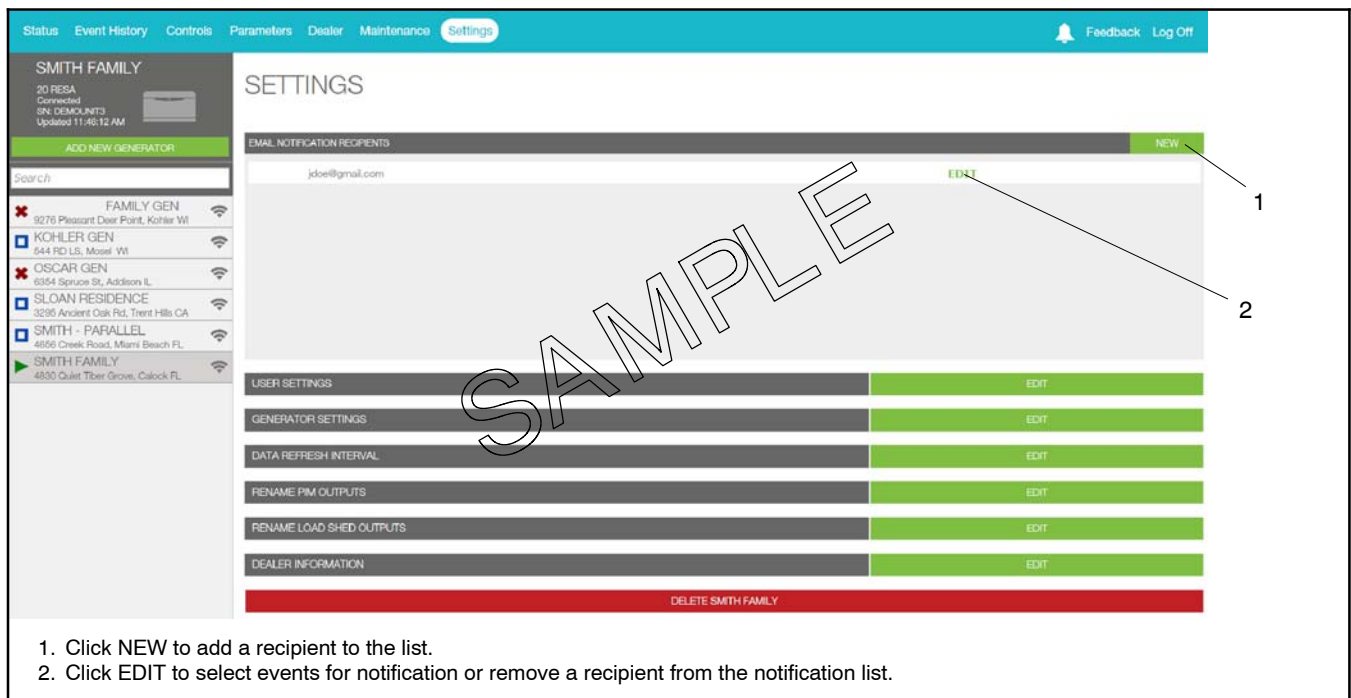

Figure 2-26 Settings

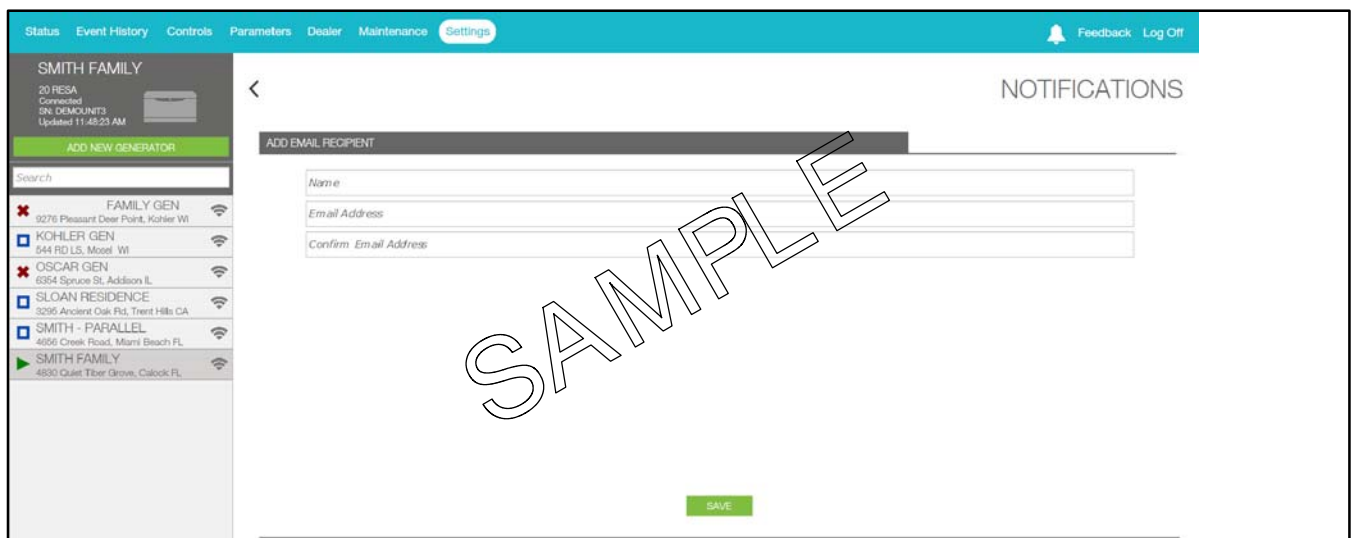

Figure 2-27 Add Email Recipient

2.17.2 Text Message Configuration

Text messages can be sent by sending an email to your cell phone.

SMS text messaging to a cellular telephone or other device is accomplished by sending an email to the cellular provider's email-to-SMS system. For example, if the customer is a subscriber of Verizon Wireless with the cellular telephone number 920-555-1212, a text message can be sent to their cell phone by sending an email to 9205551212@vtext.com. Contact your cell service provider for the email address to use for SMS text messaging.

Determine the customer's cellular telephone service provider and verify that their cell phone is equipped to receive SMS messages. Consult the cell phone provider or the provider's website for the email address configurations for text messaging. Make sure that the customer is aware of any text messaging charges the cellular telephone provider may charge for received text messages.

2.17.3 Notifications

OnCue® Plus can be configured to send email or SMS text messages alerting the recipient of generator set faults, exercise updates, and maintenance reminders.

Email and text messages include:

- Device description (user-defined)
- Generator state
- Description of the event

The events shown in Figure 2-28 will generate an email message.

A separate message is sent for each active warning and shutdown. If multiple warnings clear or shutdowns reset at the same time, you will receive one email indicating all information. See the generator set Operation Manual for a list of warnings and shutdowns.

See Section 2.17.4 for instructions to select the type of messages sent to each recipient.

Event	Notes
Exercise start/exercise ended	Exercise messages are available if a Kohler Model RXT transfer switch is connected to the generator.
Generator running/generator stopped	If a Kohler Model RXT transfer switch is connected to the generator, you will see these messages and the exercise messages when the generator exercises, if both messages are selected.
Generator in auto/not in auto	If the OFF or RUN buttons on the generator controller are pressed, the unit is not in AUTO. Remote start/stop commands will not work and scheduled exercises will not run when the unit is not in AUTO. When AUTO is pressed again, a message is sent to notify you that the generator has returned to AUTO mode.
Utility loss/utility restored	If a Kohler Model RXT transfer switch is connected to the generator, you will see these messages indicating utility power outage and restoration.
Communication loss/restored	Indicates the generator communication with the Kohler server. It has no impact on the ability of your power system to function properly.
Warnings active/cleared	Warning messages are dependent on the generator set. The message will include information about the cause of the warning; for example, low oil pressure. Note: Maintenance reminders are considered warnings. Turn on Warnings active/cleared to receive notifications of maintenance reminders.
Shutdown active/reset	Shutdown messages are dependent on the generator set. The message will include information about the cause of the shutdown; for example, high engine temperature.

Figure 2-28 Power System Events that Can Generate an Email or Text Message

2.17.4 Select Event Notifications

You can customize the email notifications sent to each recipient by selecting the events that will send an email notification for each email address. After adding email recipients, return to the Settings page and click on EDIT after the recipients email address. For each event listed in the Edit Email Recipient screen (see Figure 2-29), click on the ON/OFF box on the right to turn notification ON or OFF for each event. Each recipient can have a different combination of event notifications. Click SAVE after making the selections.

Maintenance Reminders. To receive notifications for maintenance reminders for your generator set, turn ON Warnings active/cleared. See the generator Operation Manual for a list of scheduled maintenance tasks that must be performed at regular intervals.

The default selection will send notifications for all events. Clicking RESTORE DEFAULTS turns on all notifications for the selected recipient.

Clicking DELETE will remove the recipient from the email notification list.

The screenshot shows the 'EDIT EMAIL RECIPIENT' screen. On the left, a sidebar lists generators for the 'SMITH FAMILY' account. The main area shows the recipient 'John' with email 'jdoe@gmail.com'. Below this, a list of events is shown with 'ON/OFF' toggle switches. At the bottom, there are three buttons: 'RESTORE DEFAULTS' (grey), 'SAVE' (green), and 'DELETE' (red). Numbered callouts 1, 2, 3, and 4 point to the ON/OFF toggle, the SAVE button, the RESTORE DEFAULTS button, and the DELETE button respectively.

1. Click to turn notification on or off for each event.
2. SAVE notification selections for the email recipient.
3. RESTORE DEFAULTS turns all notifications on for the selected recipient.
4. DELETE removes the recipient from the notification list.

Figure 2-29 Edit Email Recipients to Select Events for Notification or Delete an Address from the List

2.17.5 Push Notifications

Using the OnCue Plus App to Manage and View Notifications

The OnCue Plus app includes a notification center for your smart phone or tablet. The default setting will send notifications for all genset events shown in Figure 2-28. You can turn off the notifications for some events if you don't want to receive them. In order to manage your notifications, go to the Settings screen > Notification Settings > Push Notification Settings. See Figure 2-31.

See Figure 2-30 for an example of notifications.



Figure 2-30 View Notifications

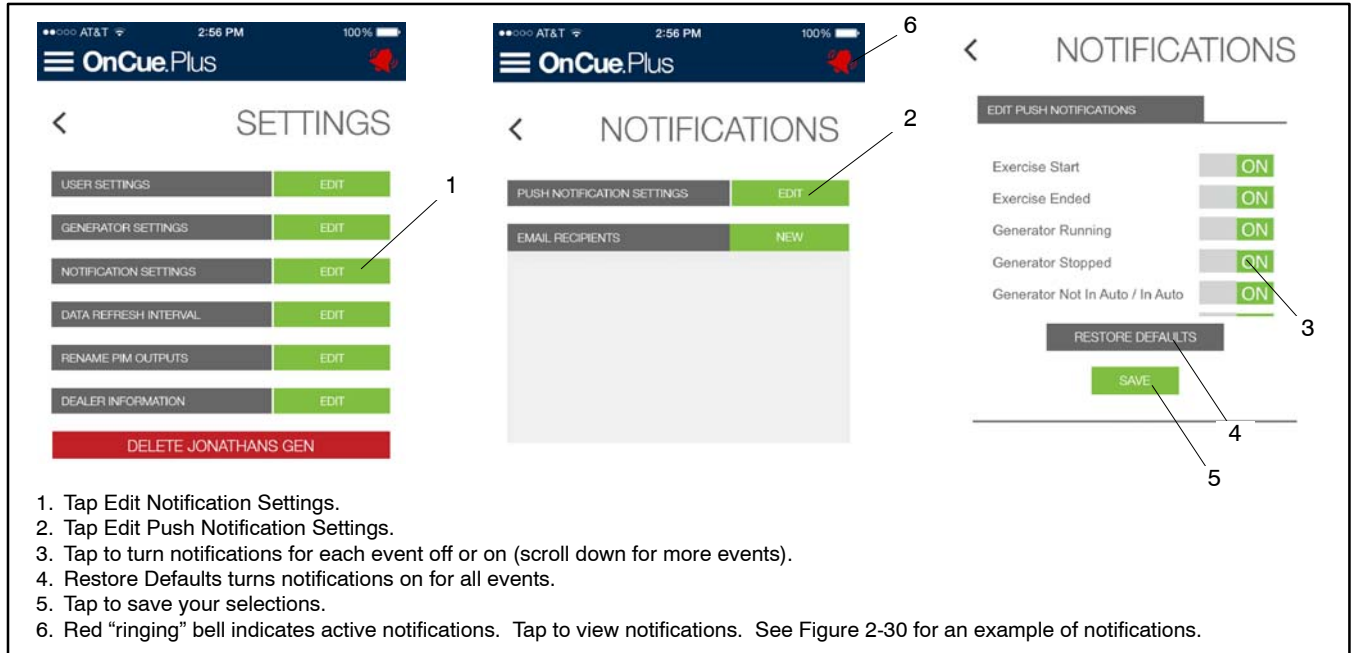

Figure 2-31 Push Notification Settings in the OnCue Plus App (for smart phones and tablets)

Viewing Push Notifications in the Web Application

Push notifications can be viewed using the OnCue Plus web application. The bell icon at the top of the screen turns red to indicate that there are notifications. See

Figure 2-32. Click on the red bell icon to view the active notifications.

See Figure 2-30 for an example of notifications.

The screenshot displays the OnCue Plus web application interface. At the top, a navigation bar includes links for Status, Event History, Controls, Parameters, Dealer, Maintenance, and Settings. A red bell icon in the top right corner, labeled with a '1', indicates active notifications. Below the navigation bar, the main content area is divided into several sections. On the left, a sidebar shows a list of generators, with 'SMITH FAMILY' selected. The main content area features a large header for 'SMITH FA...' with a status of 'Connected - Running' and 'Updated 3/27/15 10:14:48 AM'. Below this, a diagram shows a generator (GEN) connected to a house icon, with the text 'Your home is running on generator power'. To the right, three large numerical displays show '214.5v Genset Voltage', '60.0hz Frequency', and '12v Battery Voltage'. A red bell icon in the top right corner is labeled with a '1', indicating active notifications.

1. The red “ringing” bell indicates active notifications. Click on the bell to view notifications.

Figure 2-32 Notification Indicator on the Web Version of OnCue Plus

2.17.6 Data Refresh Interval

Generator data is updated in OnCue® Plus as soon as possible. In some cases, you may want to change the data updates to send data less often. For example:

- If you have a data plan that charges by the amount of data or limits the amount of data received, you may want to update less often.
- When the utility power is out and your generator set is supplying your home, you may want to select updates every 5 minutes until the utility power returns and the generator set shuts down.
- Selecting “On page load” will update the data only when you change your view in OnCue Plus.

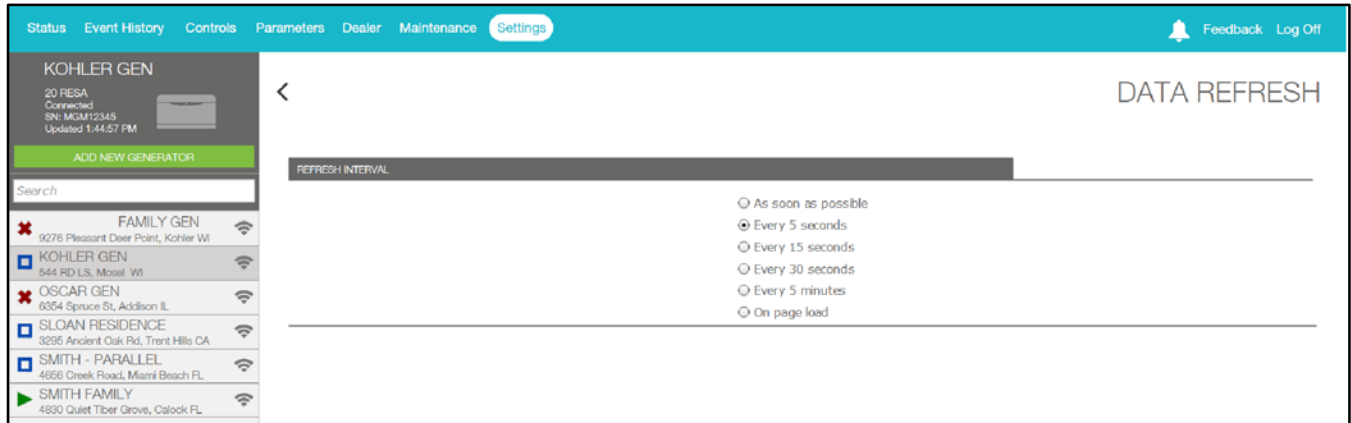

Figure 2-33 Data Refresh

2.17.7 Generator Settings

The Generator Settings view allows you to change the name and password for the generator.

Change Generator Display Name

When a generator is connected for the first time, the generator name displayed in OnCue® Plus will be the generator serial number. Use the Genset Name setting to change the name to something that identifies the generator. For example, you can rename the unit using your name or a location. If your dealer or distributor will be monitoring the generator, use a name that distinguishes your unit from other customers' equipment. Names must contain at least four characters, and can use letters and numbers.

Click on GENSET DISPLAYNAME. Type in the new name and click on the green box labeled RENAME.

Change Generator Password

Change the generator password from the 4-digit controller password to a password of your choice. If the password is changed, other users will lose the OnCue Plus connection to that generator. If your dealer is monitoring your generator, be sure to give him/her the new password.

Click on GENSET PASSWORD. Type the new password into both boxes and click CHANGE PASSWORD.

Generator Location

Click on GENSET LOCATION. Type in the new address or other information that identifies the generator location, and click on CHANGE LOCATION.

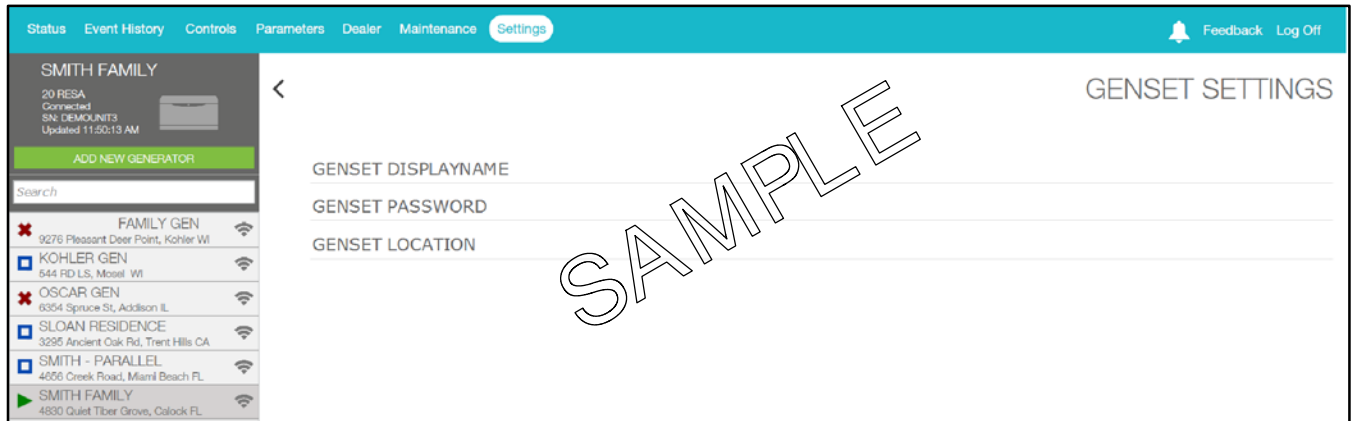

Figure 2-34 Generator Settings

2.17.8 Rename Outputs (PIM and Load Shed)

Use the Settings view to change the PIM and load shed output labels to show what is being controlled. For example, connect output 3 to the storm shutters on your vacation home and label it Storm Shutters. When bad weather is forecast, you can use OnCue Plus to close the storm shutters from a remote location. See Section 2.13, Control.

Click on EDIT after RENAME PIM OUTPUTS or RENAME LOAD SHED OUTPUTS in the Settings screen. See Figure 2-26. The RENAME screen appears. Click on the label that you want to change. Type in the new label and click RENAME. See Figure 2-35. Click on the back arrow near the upper left corner of the screen to return to the previous screen.

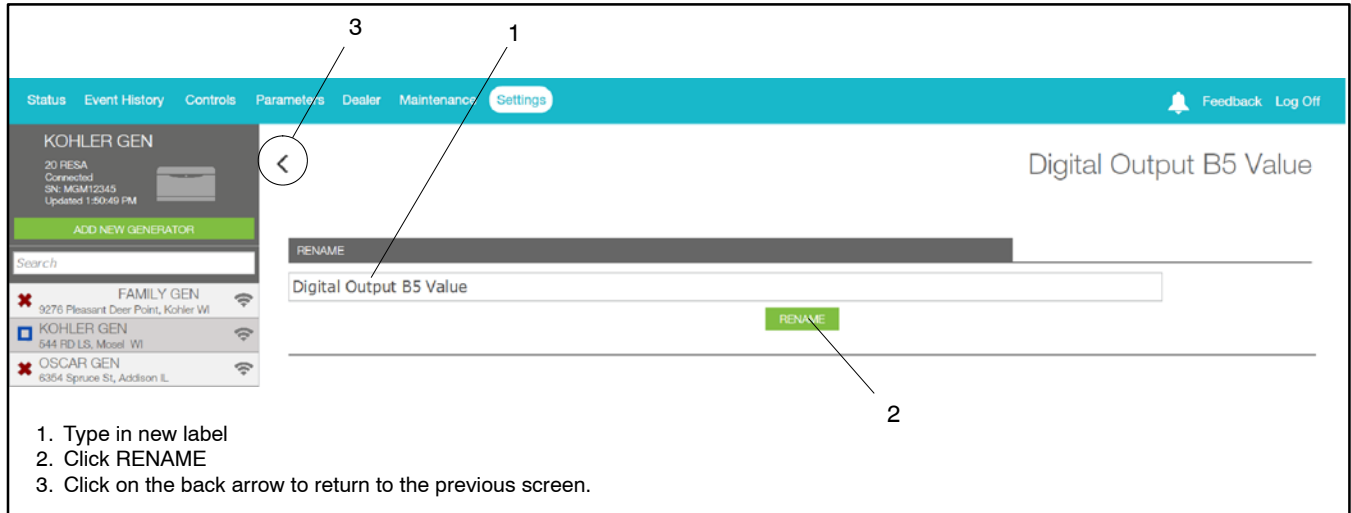

Figure 2-35 Editing PIM or Load Shed Labels

2.17.9 Dealer Information

Enter your dealer's information, including their email address. See Figure 2-37. This allows you to email your dealer using the Dealer view described earlier.

2.17.10 Delete a Generator

The Delete *Generator* command, where *Generator* is replaced with the name of the currently selected generator, allows you to remove the generator from your list of monitored units.

Go to the Add Generator view on the left and select the unit that you want to delete. Then go to Settings, and check that the Delete command shows the name of the unit that you want to remove. Touch Delete *Generator* to remove the unit from your list. A confirmation box

appears to make sure you want to delete the generator. Click Delete or Cancel.

Note: Once deleted, the generator no longer appears on the list in the Add Generator view.

After a unit has been removed, you will need to follow the Add Generator procedure to add it again if you want to put it back on your list.

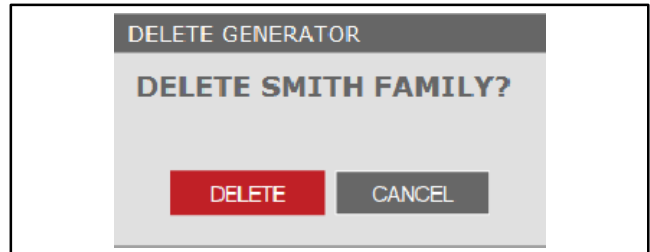

Figure 2-36 Delete a Generator

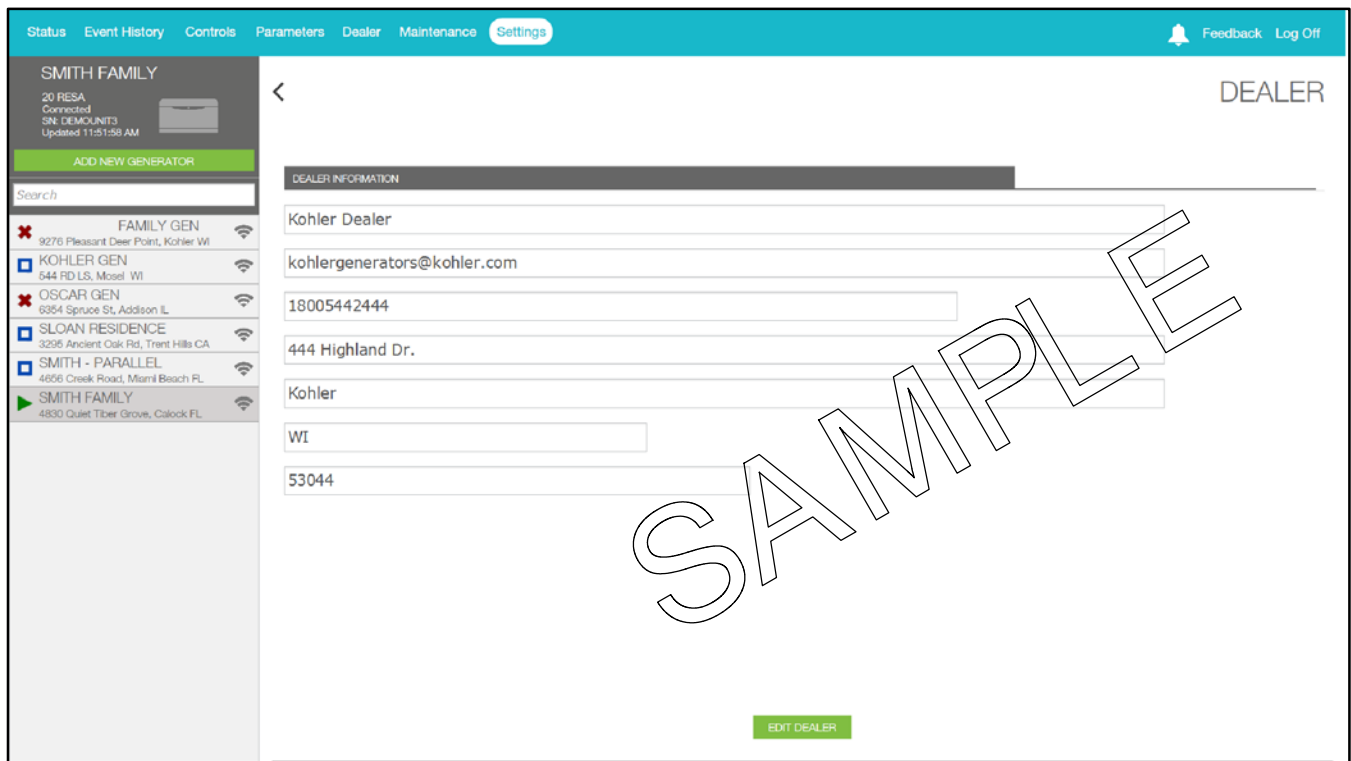

Figure 2-37 Edit Dealer Information

3.1 Introduction

This section provides instructions for troubleshooting issues related to connection of the generator to the homeowner's network. Many of these issues and connection problems are caused by incorrect controller or router setup. This section provides instructions to troubleshoot problems with the generator connection to the OnCue® Plus server.

Because of the large variety of routers that are available in the field, this document cannot address router setup issues. Please refer to the documentation provided for the router and contact the customer's Internet Service Provider (ISP), if necessary.

If you are using the OnCue® Plus Wireless kit, please also refer to TT-1618 (provided with the wireless kit) for setup, test, and troubleshooting instructions.

Refer to the generator set service manual when troubleshooting the generator set and connected equipment.

3.2 Generator Set Serial Number

Incorrect serial numbers will prevent connection to the OnCue® Plus server. Compare the genset serial number programmed into the controller with the serial number on the generator set nameplate. See Section 1.8 for instructions to find the serial number in the controller. If the S/Ns do not match, Kohler® SiteTech™ software is required to change the genset serial number programmed in the controller to match the nameplate. SiteTech software is only available to Kohler-authorized distributors and dealers. Contact a Kohler-authorized distributor/dealer for service.

3.3 Verify Power to the Controller

Verify that there is power to the generator set's controller. Check that the controller display is on or at least one LED on the controller is lit.

3.4 Check Controller's Ethernet Connection

RDC2/DC2 or VSC Controller. Check the Ethernet cable and RJ45 inline connector to the controller.

RDC/DC Controller. Make sure that the Ethernet board is installed correctly with the board-to-board connector in place. See TT-1566, Installation Instructions.

Check the firewall on the local router. Verify that router firewall port 5253 is configured to permit an outbound connection. Refer to the instructions provided with the router.

3.5 Power Cycling the Controller

The four digit password is only communicated to the OnCue® Plus Server when the controller powers up. Power cycle the controller, leaving the Ethernet cable plugged in. Power cycling can be done in one of two ways:

1. Disconnect *all* input power for two minutes (to allow capacitors to discharge):
 - a. Battery power: remove the battery negative (-) cable or disconnect P1 from the back of the controller.
 - b. Battery charger input power: disconnect the 120 VAC input power supply or disconnect P5 from the back of the controller.
 - c. Unplug the USB mini-B connector from the front of the controller (if plugged in).
 - d. Wait two minutes, then reconnect power, hooking up battery power (P1) first.

OR:

2. Re-install the controller firmware. This will force a controller reboot.

3.6 Troubleshooting Flowchart

Follow the steps in the troubleshooting procedure on the next page.

Equipment Required

The following items are necessary:

- Service laptop computer with Kohler® SiteTech™ software installed. SiteTech software is available to Kohler authorized distributors and dealers.
- USB cable, male USB A to male mini-B.
- Current (or appropriate) version of controller firmware.

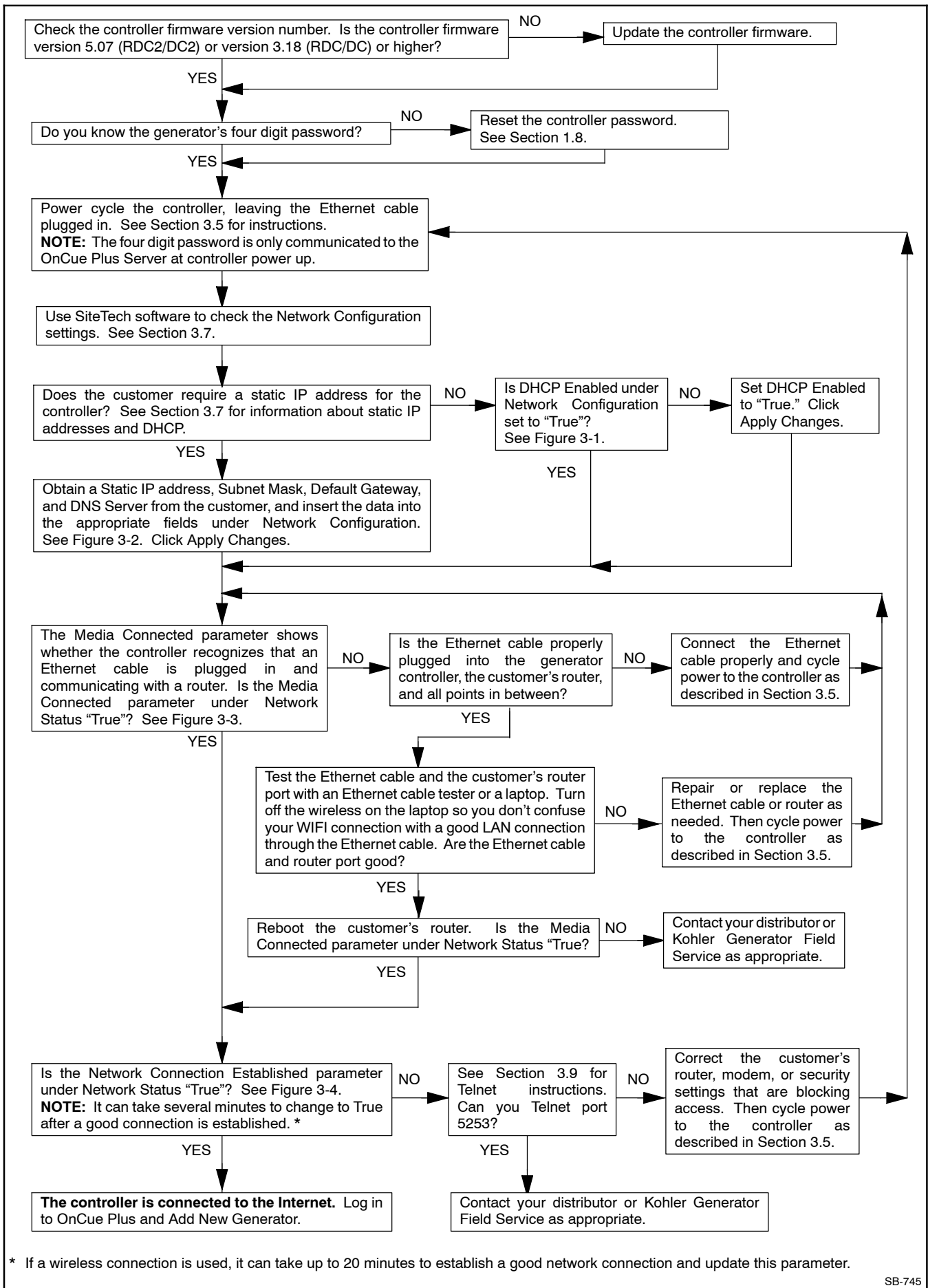

* If a wireless connection is used, it can take up to 20 minutes to establish a good network connection and update this parameter.

3.7 Network Configuration and Status

When instructed in the procedure, use your laptop and Kohler® SiteTech™ software to check the Network Configuration and Network Status settings shown in Figure 3-1 through Figure 3-4.

Dynamic Host Connection Protocol (DHCP): Most network setups use DHCP, which allows the server to assign an IP address automatically. Some sites require a static IP address that must be requested from the Internet Service Provider (ISP). The customer will know if the controller requires a static IP address. (If the customer doesn't know, he most likely does not require a static IP address.)

If a static IP address is used, obtain the IP address, subnet mask, default gateway, and DNS server from the customer and enter the data into the appropriate fields under Network Configuration. Click Apply Changes after entering the data.

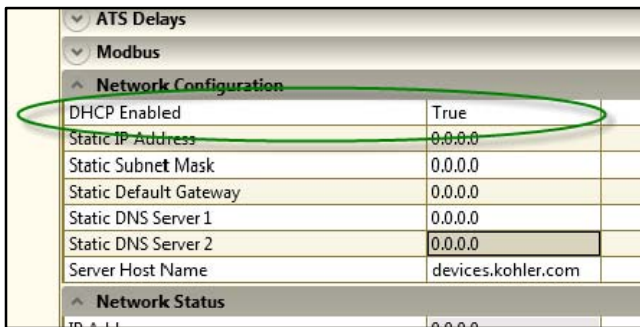

Figure 3-1 DHCP Enabled Setting

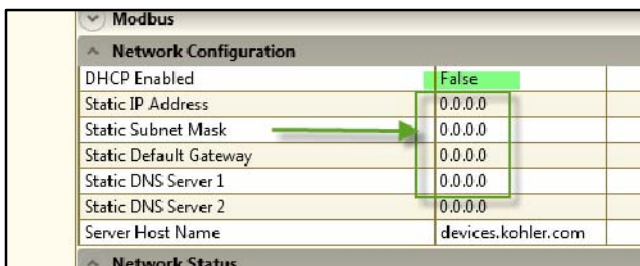

Figure 3-2 Static Settings (enter only if customer has a static IP address)

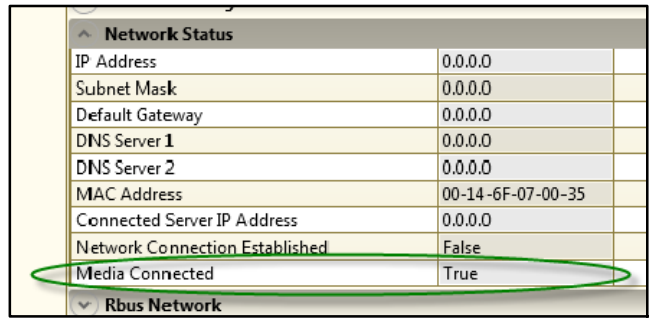

Figure 3-3 Media Connected Status = True if Controller is Connected



Figure 3-4 Network Connection Established (may take several minutes)

3.8 Check for Server Connection

3.8.1 RDC or DC Controllers

Check for a dot in the lower right corner of the RDC or DC controller display to verify that the controller is connected to the Kohler® OnCue® Plus server. See Figure 3-5.

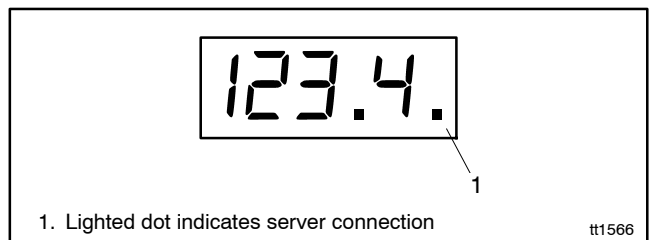

Figure 3-5 Controller Display with Server Connection Indicator

3.8.2 RDC2, DC2, or VSC Controller

If it is necessary to check the server connection to an RDC2, DC2, or VSC controller, use telnet on your PC. See Section 3.9 for instructions.

3.9 Using Telnet

Activate Telnet on your computer

Telnet is not activated by default on the Microsoft® Windows® 7 operating system. To activate Telnet on the PC, open the Control Panel, select Programs, and then select Programs and Features. Select Turn Windows Features On or Off. Find the Telnet Client and click on the box so that the box is checked. See Figure 3-6. Click OK and wait while Windows makes the adjustments.

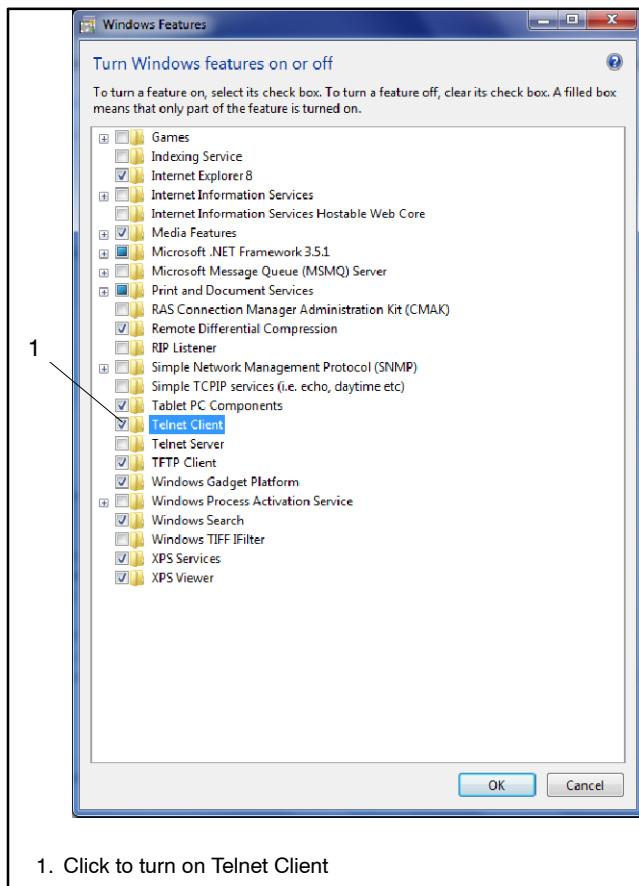

Figure 3-6 Telnet Activation, Microsoft® Windows® 7

Now use Telnet to check the server connection to OnCue Plus.

Telnet Procedure

1. Open a command prompt window on the PC by selecting Start, All Programs, Accessories, Command Prompt. See Figure 3-7.

Microsoft® and Windows® are registered trademarks of Microsoft Corporation.

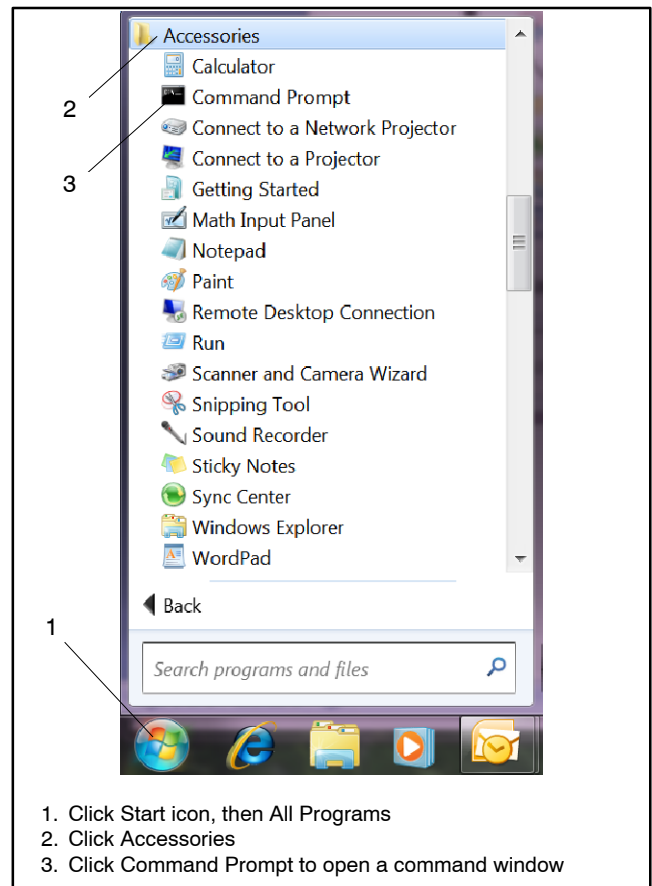

Figure 3-7 Opening a Command Prompt Window

2. Using the command prompt window, try to telnet to the OnCue Plus server by entering the following:

```
c:\> telnet devices.kohler.com 5253
```
3. If the connection was successfully established, you will see the symbols shown in Figure 3-8.

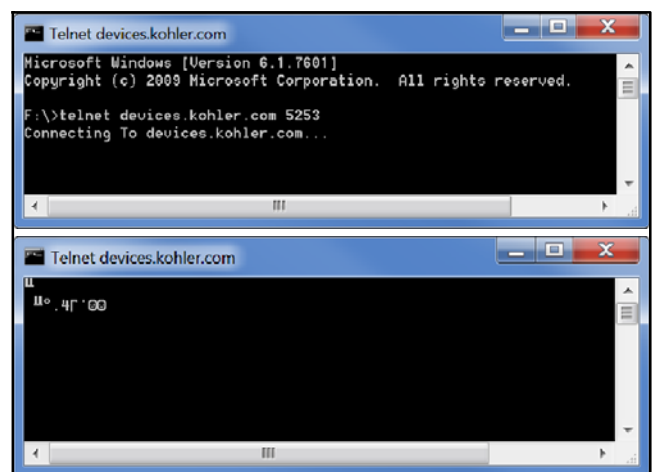

Figure 3-8 Telnet Command to Confirm OnCue® Plus Server Connection

3.10 Other Issues

Figure 3-9 lists some additional things to check when troubleshooting connection problems.

Possible Cause of Connection Problem	Suggested Solution
Internet service is down	Verify that Internet service is available by navigating to www.KOHLERPower.com or any website.
No power to controller	Verify power to the generator set controller by checking that the controller display is on or one LED is illuminated or flashing on the controller. Check the connection to the generator set's engine starting battery. RDC/DC controller. Check the condition of the controller's F3 fuse, and replace the fuse if necessary.
No connection to the server	RDC2/DC2/VSC controller. Test server connection using telnet. See Section 3.8.2. RDC/DC controller. Check that the server connection indicating LED on the controller is lit. See Sections 3.3 and 3.8.
Cable or modem/router problem	Note: RDC2/DC2/VSC controller. Disconnect the utility power to the generator set before disconnecting the Ethernet cable. Follow the safety precautions in this document and in the generator set service manual. Note: RDC/DC controller. Remove the controller's F3 fuse and disconnect power to the generator set before disconnecting the Ethernet cable. Follow the safety precautions in this document and in the generator set service manual. See TT-1566, Ethernet Board Installation Instructions, for connection details. Isolate the problem by disconnecting the Ethernet cable from the generator controller and plugging it into a laptop PC. Disable wireless on the laptop. Check Internet access by trying to connect to www.KOHLERPower.com or any website. <ul style="list-style-type: none"> ● If no connection, try to connect the laptop PC to the modem/router using a different cable. ● If there is no connection with either cable, the problem may be with the modem/router. Contact your Internet Server Provider for assistance.
OnCue Plus Wireless connection issues	See TT-1618 for instructions to activate the Watchdog and troubleshoot the wireless connection.
Long network cables may cause excessive signal loss	If the network cable is longer than 100 meters (328 ft.), install a repeater or switch.
Password error	Reset the password at the controller, if necessary, and enter the new password in OnCue Plus. See Section 2.7.
Generator set serial number mismatch	See Section 3.2.
Firewall blocking access	On the generator set side, configure the router firewall to open port 5253 to permit an outbound connection. Contact your system administrator or Internet service provider for assistance, if necessary.
Other	Contact your Internet Server Provider for assistance.

Figure 3-9 Other Possible Causes of Connection Problems

Notes

Appendix A Abbreviations

The following list contains abbreviations that may appear in this publication.

A, amp	ampere	cfm	cubic feet per minute	exh.	exhaust
ABDC	after bottom dead center	CG	center of gravity	ext.	external
AC	alternating current	CID	cubic inch displacement	F	Fahrenheit, female
A/D	analog to digital	CL	centerline	FHM	flat head machine (screw)
ADC	advanced digital control; analog to digital converter	cm	centimeter	fl. oz.	fluid ounce
adj.	adjust, adjustment	CMOS	complementary metal oxide substrate (semiconductor)	flex.	flexible
ADV	advertising dimensional drawing	com	communications (port)	freq.	frequency
Ah	amp-hour	coml	commercial	FS	full scale
AHWT	anticipatory high water temperature	Coml/Rec	Commercial/Recreational connection	ft.	foot, feet
AISI	American Iron and Steel Institute	conn.	connection	ft. lb.	foot pounds (torque)
ALOP	anticipatory low oil pressure	cont.	continued	ft./min.	feet per minute
alt.	alternator	CPVC	chlorinated polyvinyl chloride	ftp	file transfer protocol
Al	aluminum	crit.	critical	g	gram
ANSI	American National Standards Institute (formerly American Standards Association, ASA)	CSA	Canadian Standards Association	ga.	gauge (meters, wire size)
AO	anticipatory only	CT	current transformer	gal.	gallon
APDC	Air Pollution Control District	Cu	copper	gen.	generator
API	American Petroleum Institute	cUL	Canadian Underwriter's Laboratories	genset	generator set
approx.	approximate, approximately	CUL	Canadian Underwriter's Laboratories	GFI	ground fault interrupter
APU	Auxiliary Power Unit	cu. in.	cubic inch	GND, ⊕	ground
AQMD	Air Quality Management District	cw.	clockwise	gov.	governor
AR	as required, as requested	CWC	city water-cooled	gph	gallons per hour
AS	as supplied, as stated, as suggested	cyl.	cylinder	gpm	gallons per minute
ASE	American Society of Engineers	D/A	digital to analog	gr.	grade, gross
ASME	American Society of Mechanical Engineers	DAC	digital to analog converter	GRD	equipment ground
assy.	assembly	dB	decibel	gr. wt.	gross weight
ASTM	American Society for Testing Materials	dB(A)	decibel (A weighted)	H x W x D	height by width by depth
ATDC	after top dead center	DC	direct current	HC	hex cap
ATS	automatic transfer switch	DCR	direct current resistance	HCHT	high cylinder head temperature
auto.	automatic	deg., °	degree	HD	heavy duty
aux.	auxiliary	dept.	department	HET	high exhaust temp., high engine temp.
avg.	average	dia.	diameter	hex	hexagon
AVR	automatic voltage regulator	DI/EO	dual inlet/end outlet	Hg	mercury (element)
AWG	American Wire Gauge	DIN	Deutsches Institut fur Normung e. V. (also Deutsche Industrie Normenausschuss)	HH	hex head
AWM	appliance wiring material	DIP	dual inline package	HHC	hex head cap
bat.	battery	DPDT	double-pole, double-throw	HP	horsepower
BBDC	before bottom dead center	DPST	double-pole, single-throw	hr.	hour
BC	battery charger, battery charging	DS	disconnect switch	HS	heat shrink
BCA	battery charging alternator	DVR	digital voltage regulator	hsg.	housing
BCI	Battery Council International	E ² PROM, EEPROM	electrically-erasable programmable read-only memory	HVAC	heating, ventilation, and air conditioning
BDC	before dead center	E, emer.	emergency (power source)	HWT	high water temperature
BHP	brake horsepower	ECM	electronic control module, engine control module	Hz	hertz (cycles per second)
blk.	black (paint color), block (engine)	EDI	electronic data interchange	IBC	International Building Code
blk. htr.	block heater	EFR	emergency frequency relay	IC	integrated circuit
BMEP	brake mean effective pressure	e.g.	for example (<i>exempli gratia</i>)	ID	inside diameter, identification
bps	bits per second	EG	electronic governor	IEC	International Electrotechnical Commission
br.	brass	EGSA	Electrical Generating Systems Association	IEEE	Institute of Electrical and Electronics Engineers
BTDC	before top dead center	EIA	Electronic Industries Association	IMS	improved motor starting
Btu	British thermal unit	EI/EO	end inlet/end outlet	in.	inch
Btu/min.	British thermal units per minute	EMI	electromagnetic interference	in. H ₂ O	inches of water
C	Celsius, centigrade	emiss.	emission	in. Hg	inches of mercury
cal.	calorie	eng.	engine	in. lb.	inch pounds
CAN	controller area network	EPA	Environmental Protection Agency	Inc.	incorporated
CARB	California Air Resources Board	EPS	emergency power system	ind.	industrial
CAT5	Category 5 (network cable)	ER	emergency relay	int.	internal
CB	circuit breaker	ES	engineering special, engineered special	int./ext.	internal/external
CC	crank cycle	ESD	electrostatic discharge	I/O	input/output
cc	cubic centimeter	est.	estimated	IP	internet protocol
CCA	cold cranking amps	E-Stop	emergency stop	ISO	International Organization for Standardization
ccw.	counterclockwise	etc.	et cetera (and so forth)	J	joule
CEC	Canadian Electrical Code			JIS	Japanese Industry Standard
cert.	certificate, certification, certified			k	kilo (1000)
cfh	cubic feet per hour			K	kelvin
				kA	kiloampere
				KB	kilobyte (2 ¹⁰ bytes)
				KBus	Kohler communication protocol
				kg	kilogram

kg/cm ²	kilograms per square centimeter	NC	normally closed	RTU	remote terminal unit
kgm	kilogram-meter	NEC	National Electrical Code	RTV	room temperature vulcanization
kg/m ³	kilograms per cubic meter	NEMA	National Electrical Manufacturers Association	RW	read/write
kHz	kilohertz	NFPA	National Fire Protection Association	SAE	Society of Automotive Engineers
kJ	kilojoule	Nm	newton meter	scfm	standard cubic feet per minute
km	kilometer	NO	normally open	SCR	silicon controlled rectifier
kOhm, kΩ	kilo-ohm	no., nos.	number, numbers	s, sec.	second
kPa	kilopascal	NPS	National Pipe, Straight	SI	<i>Systeme international d'unites</i> , International System of Units
kph	kilometers per hour	NPSC	National Pipe, Straight-coupling	SI/EO	side in/end out
kV	kilovolt	NPT	National Standard taper pipe thread per general use	sil.	silencer
kVA	kilovolt ampere	NPTF	National Pipe, Taper-Fine	SMTP	simple mail transfer protocol
kVAR	kilovolt ampere reactive	NR	not required, normal relay	SN	serial number
kW	kilowatt	ns	nanosecond	SNMP	simple network management protocol
kWh	kilowatt-hour	OC	overcrank	SPDT	single-pole, double-throw
kWm	kilowatt mechanical	OD	outside diameter	SPST	single-pole, single-throw
kWth	kilowatt-thermal	OEM	original equipment manufacturer	spec	specification
L	liter	OF	overfrequency	specs	specification(s)
LAN	local area network	opt.	option, optional	sq.	square
L x W x H	length by width by height	OS	oversize, overspeed	sq. cm	square centimeter
lb.	pound, pounds	OSHA	Occupational Safety and Health Administration	sq. in.	square inch
lbm/ft ³	pounds mass per cubic feet	OV	overvoltage	SMS	short message service
LCB	line circuit breaker	oz.	ounce	SS	stainless steel
LCD	liquid crystal display	p., pp.	page, pages	std.	standard
LED	light emitting diode	PC	personal computer	stl.	steel
Lph	liters per hour	PCB	printed circuit board	tach.	tachometer
Lpm	liters per minute	pF	picofarad	TB	terminal block
LOP	low oil pressure	PF	power factor	TCP	transmission control protocol
LP	liquefied petroleum	ph., ∅	phase	TD	time delay
LPG	liquefied petroleum gas	PHC	Phillips® head CrimpTite® (screw)	TDC	top dead center
LS	left side	PHH	Phillips® hex head (screw)	TDEC	time delay engine cooldown
L _{wa}	sound power level, A weighted	PHM	pan head machine (screw)	TDEN	time delay emergency to normal
LWL	low water level	PLC	programmable logic control	TDES	time delay engine start
LWT	low water temperature	PLC	programmable logic control	TDNE	time delay normal to emergency
m	meter, milli (1/1000)	PMG	permanent magnet generator	TDOE	time delay off to emergency
M	mega (10 ⁶ when used with SI units), male	pot	potentiometer, potential	TDON	time delay off to normal
m ³	cubic meter	ppm	parts per million	temp.	temperature
m ³ /hr.	cubic meters per hour	PROM	programmable read-only memory	term.	terminal
m ³ /min.	cubic meters per minute	psi	pounds per square inch	THD	total harmonic distortion
mA	milliampere	psig	pounds per square inch gauge	TIF	telephone influence factor
man.	manual	pt.	pint	tol.	tolerance
max.	maximum	PTC	positive temperature coefficient	turbo.	turbocharger
MB	megabyte (2 ²⁰ bytes)	PTO	power takeoff	typ.	typical (same in multiple locations)
MCCB	molded-case circuit breaker	PVC	polyvinyl chloride	UF	underfrequency
MCM	one thousand circular mils	qt.	quart, quarts	UHF	ultrahigh frequency
megggar	megohmmeter	qty.	quantity	UIF	user interface
MHz	megahertz	R	replacement (emergency)	UL	Underwriter's Laboratories, Inc.
mi.	mile	rad.	radiator, radius	UNC	unified coarse thread (was NC)
mil	one one-thousandth of an inch	RAM	random access memory	UNF	unified fine thread (was NF)
min.	minimum, minute	RBUS	RS-485 proprietary communications	univ.	universal
misc.	miscellaneous	RDO	relay driver output	URL	uniform resource locator (web address)
MJ	megajoule	ref.	reference	US	undersize, underspeed
mJ	millijoule	rem.	remote	UV	ultraviolet, undervoltage
mm	millimeter	Res/Coml	Residential/Commercial	V	volt
mOhm, mΩ	milliohm	RFI	radio frequency interference	VAC	volts alternating current
MOhm, MΩ	megohm	RH	round head	VAR	voltampere reactive
MOV	metal oxide varistor	RHM	round head machine (screw)	VDC	volts direct current
MPa	megapascal	rly.	relay	VFD	vacuum fluorescent display
mpg	miles per gallon	rms	root mean square	VGA	video graphics adapter
mph	miles per hour	rnd.	round	VHF	very high frequency
MS	military standard	RO	read only	W	watt
ms	millisecond	ROM	read only memory	WCR	withstand and closing rating
m/sec.	meters per second	rot.	rotate, rotating	w/	with
mtg.	mounting	rpm	revolutions per minute	WO	write only
MTU	Motoren-und Turbinen-Union	RS	right side	w/o	without
MW	megawatt	RTDs	Resistance Temperature Detectors	wt.	weight
mW	milliwatt			xfmr	transformer
μF	microfarad				
N, norm.	normal (power source)				
NA	not available, not applicable				
nat. gas	natural gas				
NBS	National Bureau of Standards				

Notes

Notes

KOHLER[®] Power Systems

KOHLER CO. Kohler, Wisconsin 53044
Phone 920-457-4441, Fax 920-459-1646

Kohler Power Systems
Asia Pacific Headquarters
7 Jurong Pier Road
Singapore 619159
Phone (65) 6264-6422, Fax (65) 6264-6455

**For the nearest KOHLER authorized
installation, service, and sales dealer
in the US and Canada:
Call 1-800-544-2444 or visit
KOHLERPower.com**

TP-6928 4/15d

© 2014, 2015 by Kohler Co. All rights reserved.